



## Tool Clamping

Collets - Clamping Nuts  
Wrenches - Collet Holders  
Tapping Attachments - Quick Change Chucks



## Overview of Contents

Page

The trademark FAHRION	4
FAHRION Protect	8
Advantages of FAHRION Collets	10
Features of FAHRION Collets	10
The FAHRION quality label	11
Effect of runout on the cutting edges	11
Influence of collet accuracy on the life of carbide cutting tools	11
Cost example	11

## Collets, Clamping Nuts and Wrenches for Tool Clamping

Collets GERC   CER   CET DIN ISO 15488 (ER/ESX)	13
Taper Wipers KWK-ER for Collet Closing Tapers DIN ISO 15488 (ER/ESX)	21
Clamping Nuts STM DIN ISO 15488 (ER/ESX)	22
Sealing Discs DI for Clamping Nuts STM DIN ISO 15488 (ER/ESX)	24
Wrenches RO   DRO   DRMO for Clamping Nuts STM DIN ISO 15488 (ER/ESX)	25
Wrenches SCHL for Clamping Nuts DIN ISO 15488 (ER/ESX)	26
Collets GOZ DIN ISO 10897 (OZ)	27
Clamping Nuts KM   KM-DIG DIN ISO 10897 (OZ)	28
Sealing Discs DIG for Clamping Nuts KM DIN ISO 10897 (OZ)	29
Wrenches SCHL for Clamping Nuts KM DIN ISO 10897 (OZ)	29
Collets RFJ Rubber-Flex®	30
Clamping Nuts STMRF Rubber-Flex®	30
Wrenches SCHL for Clamping Nuts Rubber-Flex®	30
Split Sleeves SL-BO DIN 6329 with Morse Taper	31
Split Sleeves SL-GB DIN 6328 with Morse Taper	31

## Collet Holders for Tool Clamping

Collet Holders HFER-MK with Morse Taper	32
Collet Holders HF-MK with Morse Taper	32
Collet Holders HFER-Z with Cylindrical Shank	33
Collet Holders HFERM-Z with Cylindrical Shank	34
Collet Holders HFERM-ZW with Cylindrical Shank and Flat	35
Collet Holders NCER-ZW with Cylindrical Shank and Flat	37
Collet Holders HFERM-B with B-Taper and Flat	37

## Tapping Attachments

Tapping Attachments GAN with Morse Taper Shank	38
Tapping Holders GHN with Morse Taper Shank	38

## Quick Change Chucks with Accessories

Quick Change Chucks SF with Morse Taper Shank for Tool Adaptors E, Floating Adaptors PE and Tapping Adaptors GE	39
--	----

## Appendix

Concentricity Charts for Collets DIN ISO 15488 (ER/ESX)	42
Concentricity Charts for Collets DIN ISO 10897 (OZ)	43
Build-in Dimensions for Collets DIN ISO 15488 (ER/ESX)	43
Tightening Torque for Clamping Nuts DIN ISO 15488 (ER/ESX)	44
Assembly Instructions for Collets and Clamping Nuts DIN ISO 15488 (ER/ESX) and DIN ISO 10897 (OZ)	45
Tap Shank Dimensions DIN/ISO	46



# Straight.

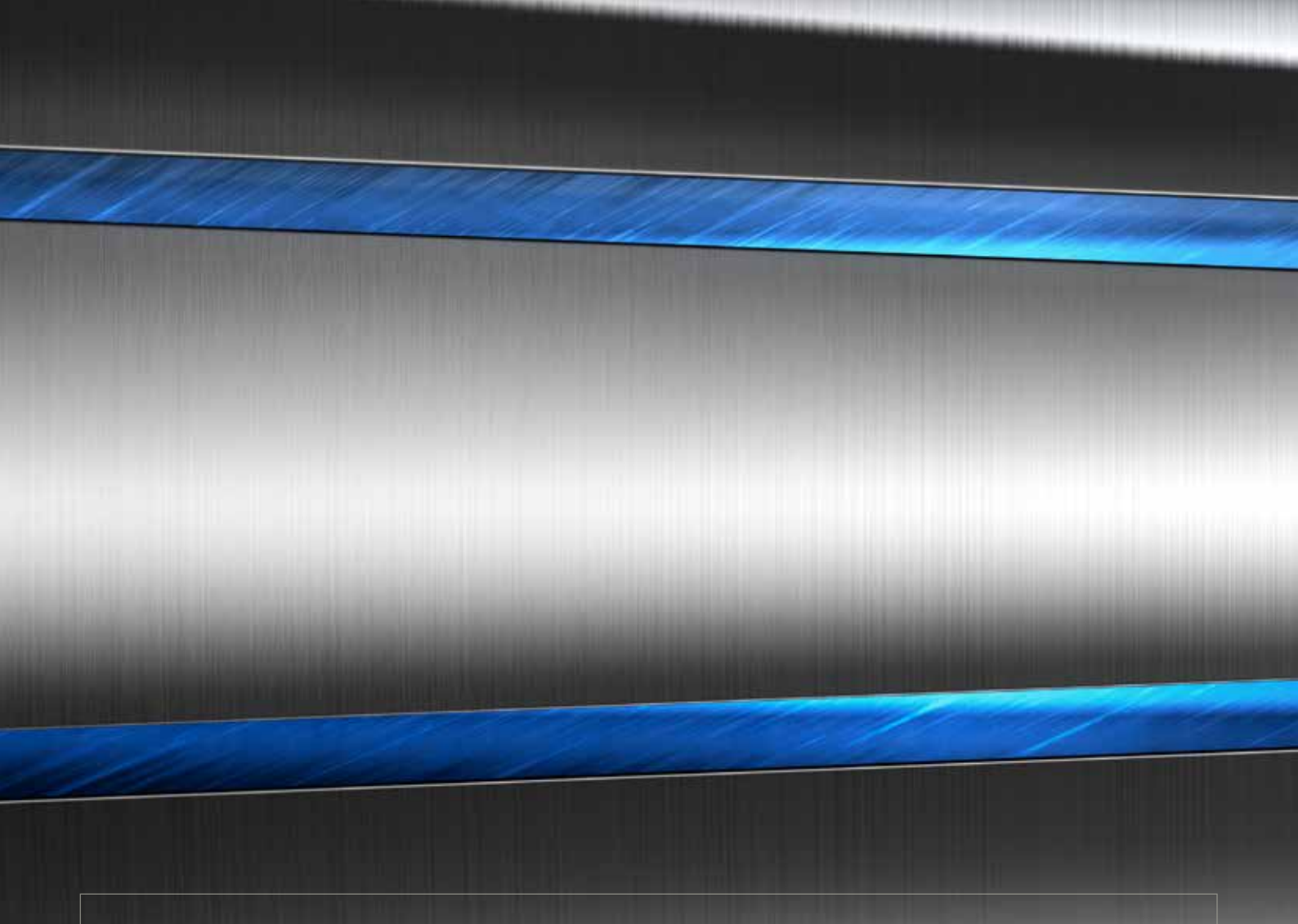

The direct way to success: Due to a uniquely clear and specific design, supreme production quality and consistent service orientation, FAHRION makes your work easier, more efficient, faster and more precise with its comprehensive range of tool clamping systems. Just right for demanding production tasks.

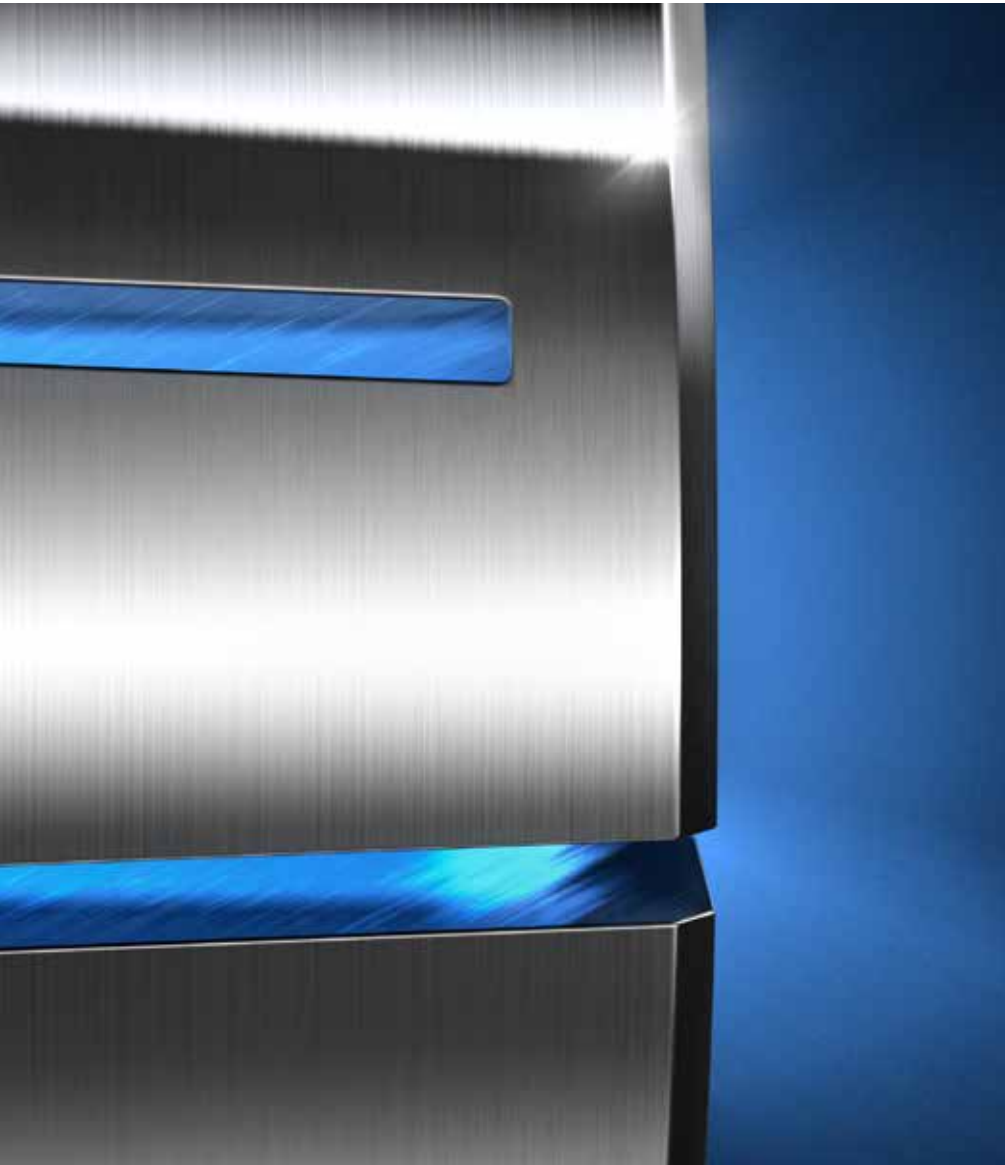

Close to your demands:  
Every detail is optimized for  
maximum functionality.

For decades, FAHRION has been following an uncompromising line, when it comes to supporting your work: All FAHRION products and services are directed to convince with maximum functionality and application orientation – at an excellent price-performance ratio.

In terms of quality, FAHRION products offer performance values already in the standard product range which for other producers are limited to expensive premium series. Our DIN ISO 15488 (ER/ESX) and DIN ISO 10897 (OZ) based precision collets are produced with tolerance values which lie significantly below the required DIN norm.

Together with the patented FAHRION precision collet chuck CENTRO|P and other high performance system components, our collets form a perfectly integrated complete system which guarantees maximum precision, stability, flexibility, reliability and cost effectiveness.

At the same time FAHRION is a manufacturer which continuously and critically monitors and optimizes its product portfolio – therefore, FAHRION technology brings you the maximum possible benefit at any time and with every order.

# Evident.



FAHRION clamping systems can manage highly complex challenges. At the same time we have done everything to ensure that our solutions remain conceivably uncomplicated and highly transparent for you. This way, you can assure a distinct advantage in terms of profitability.

#### **Focused on the user**

FAHRION user-friendliness starts with the product range. We provide exactly those solutions which you need in your daily work – and only technology which really provides functionality enters FAHRION's clamping systems.

In addition to the common models, we do not only offer products which meet very special process requirements, but which can, nevertheless, be also easily assembled and effectively used. We support you with all our expertise in finding and using your dedicated FAHRION solution – for example in the FAHRION Technology Centre, where we convey broad know-how under real working conditions.

# Smooth.



All runs smoothly – with excellent results: That is our promise to everyone who trusts in FAHRION clamping systems. Production processes with FAHRION solutions provide exactly those results which meet your specifications – with especially careful use of your valuable machinery.

**Optimize your process**

Excellent concentricity and repeatability, optimal balancing quality, perfectly matched and carefully tested system solutions: These are only a few of the technical features which assure that you can completely rely on FAHRION products.

Thanks to the smooth production processes in the highest quality, you can deliver the requested parts more quickly to your customers, while customer satisfaction ensures profitable follow-up orders. In addition, less process steps are required because the FAHRION precision reduces the number of faulty products – and thus the need for post processing work – to a minimum. Moreover, long service life of machine and tools is guaranteed with your own machine technology.

# FAHRION|Protect



Rust on collets reduces the lifetime of your tools and leads to significant loss of precision. Therefore, we have now developed FAHRION|Protect: A pioneering new technology which protects collets from corrosion in the long term.





## Collets with corrosion protection of the functional surfaces in the $\mu$ -range

FAHRION|Protect goes beyond all standards that you know in corrosion protection of clamping tools. Many clamping tools are not protected at all. With others, the corrosion protection is limited to the visible areas only. Or with cutting tools with insert pockets, only an accuracy of about 0.01 mm is required.

FAHRION is the first manufacturer to offer a coating of the functional surfaces in the  $\mu$ -range – over its complete and finely tuned product range. FAHRION|Protect conserves FAHRION collets effectively from external influences and preserves their functionality and precision for a longer time. That is how FAHRION shows once again in an impressive way how advanced technology can be brought to the market as an integrated customer solution.



Two collets each after 4 months of use:  
 The left one without coating – the right one with FAHRION|Protect

**FAHRION|Protect:**  
**Stops corrosion. Solves the problems.**

The comparison with conventional unprotected collets shows: Without a coating, the collet is affected by corrosion in a short time – whether by humidity, cooling lubricant, cleaning solutions, salts or gases. This does not only affect the collet but also your complete system.

**Optimize your work in many ways:**

Coated collets by FAHRION are corrosion protection, quality protection, investment protection and environmental protection all in one:

- The nominal geometry between the collet and the taper seat in the chuck is maintained for a long lasting permanent surface contact without corrosion-related irregularities.
- The parts in manufacturing stay longer in the specified tolerances. The number of faulty parts decreases.
- You can keep production processes longer on a high level, you can save time and you can also guarantee short terms of delivery.
- A higher concentricity extends the tool lives. Thus, you save time and money by reducing set up times.
- Collets have to be replaced less frequently or can be used longer for precision applications.
- Less imbalance on the tools relieves the machine spindle permanently – your maintenance costs will be reduced.
- Longer service life saves valuable resources.

The new technology is established in the FAHRION factory and integrated in the production process. This means: no matter in which field or which type of collets you use – you can benefit from the new technology in any case

# Advantages of FAHRION Collets

## DIN ISO 15488 - GERC-B and GERC-HP (ER/ESX)

FAHRION provides the largest range of forms and executions of collets DIN ISO 15488 (ER/ESX) for different applications

### Precise

FAHRION collets DIN ISO 15488-B (ER/ESX) set the standard of concentricity and repeatability, which is 5 µm for the types GERC11-B up to GERC40-B and 2 µm for the types GERC11-HP up to GERC40-HP

### Rigid

12 slots are sufficient in order to reach the required collapse to DIN ISO 15488. This is possible because of a special steel produced for us and a particular harmonized heat treatment. Compared to 16 slot collets, our collets have less tendency to distort

### Saving

all edges are not only deburred, but additionally rounded, which is a prerequisite to protect the inner cone of the collet chuck from marks. This process is important to guarantee a consistent repeatable high accuracy

Increased rigidity and clamping forces, improved grip, higher precision and system concentricity, enhanced resistance to corrosion for GERC-B and GERC-HP due to super-finished execution with FAHRION|Protect!

In addition to slots being deburred, finish of operating surfaces  $\leq 1,6 \mu\text{m}$



Features of FAHRION Collets DIN ISO 15488 (ER/ESX)

Form/Application	GERC-B	GERC-BD	GERC-HP	GERC-HPD	GERC-HPDD	CER-K2	GERC-GBD	GERC-GBDD	CET-GB
DIN ISO 15488 - form	B	A <sup>2</sup>	B	A <sup>2</sup>	A <sup>2</sup>	B	A <sup>2</sup>	A <sup>2</sup>	A <sup>3</sup>
Standard Collet Chucks	X	X	X	X	X	X	X	X	X
FAHRION Precision Collet Chucks CENTRO P	X <sup>4</sup>	X <sup>4</sup>	X	X	X	-	X	X	-
FAHRION Protect	X	X	X	X	X	-	X	X	-
Concentricity e.g. Ø 12,0 mm	5 µm	5 µm	2 µm	2 µm	2 µm	15 µm	10 µm	10 µm	20 µm
Repeatability	5 µm	5 µm	2 µm	2 µm	2 µm	10 µm	6 µm	6 µm	10 µm
Concentricity important	X	X	X	X	X	-	-	-	-
Concentricity very important for HSC	-	-	X	X	X	-	-	-	-
Concentricity/tool life unimportant	-	-	-	-	-	X	-	-	-
Collapse	0,5-1 mm	h8	h10 <sup>5</sup>	h8	h8	0,5-2 mm	h8	h8	-
Sealing for IC (inner coolant supply)	-	X	-	X	X	-	X	X	-
Jet holes for Inner Coolant Supply	-	-	-	-	X	-	-	X	-
For tapping with internal square drive	-	-	-	-	-	-	X	X	-
With incorporated axial compensation	-	-	-	-	-	-	-	-	X
Details to be found on page	13	14	15	16	17	18	19	20	21

<sup>1</sup> unless otherwise indicated, form GERC-B will be supplied!

<sup>2</sup> similar to DIN ISO 15488 form A, fit in Standard Collet Chucks as well as in the Precision Collet Chucks CENTRO|P

<sup>3</sup> not suitable for Precision Collet Chucks CENTRO|P

<sup>4</sup> can be used, but the concentricity of the complete system is influenced

<sup>5</sup> highest concentricity of the complete system when clamping nominal size Ø h10, collapse 0,5-1 mm in standard collet chucks can be achieved (remove blue recognition ring)

## Quality pays

**Blue Ring = Quality**  
 Official designation  
 of 2µm collets

Series-No.

Diameter



**FAHRION**  
 trademark for  
 tested quality

Higher tool working life, lower  
 tool costs, less setting up time  
 = Lower production costs  
 Better surface finishes and  
 tighter production tolerances  
 = Improved quality

### Effect of runout on the cutting edges

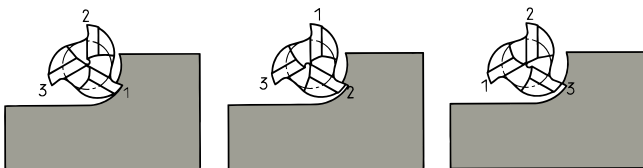

Irregular load on  
 the cutting edges

Wear on tool increa-  
 ses, surface quality  
 of the workpiece is  
 getting worse

Feed has to be  
 reduced

### Influence of collet accuracy on the life of carbide cutting tools

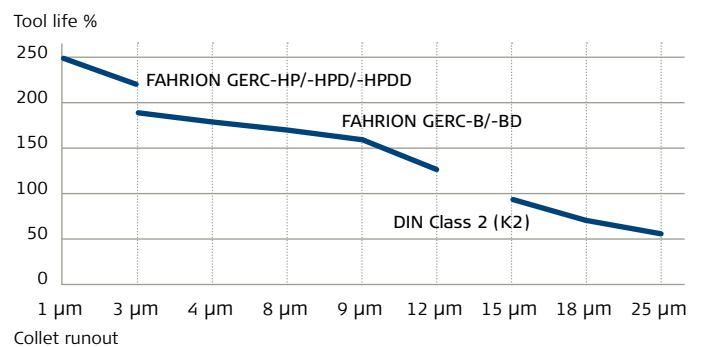

### Cost example for a carbide drill Ø 12 mm with collet DIN ISO 15488 - form B, type 470 E

#### Example 1: system concentricity ≤ 10 µm

Cost of a carbide drill	approx. 105,00 €
Cost FAHRION GERC32-B collet with concentricity 5 µm	approx. 20,50 €

**Cost on basis of tool life of approx. 150 % approx. 125,50 €**

#### Example 2: system concentricity ≤ 25 µm

Cost of a carbide drill	approx. 105,00 €
Cost CER32-K2 collet DIN class 2 with concentricity 20 µm	approx. 13,20 €

**Cost on basis of tool life of approx. 55 % approx. 118,20 €**

**Cost for similar tool life of approx. 150 % approx. 322,00 €**

More than two carbide drills necessary!

**Result: Cheap collets almost triple the cost!**

# The FAHRION Product Range

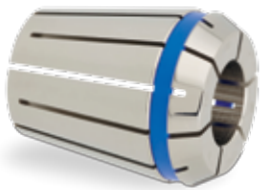

Precision Collets



Precision Collet Chucks CENTRO|P



Tapping Chucks SYNCHRO|T



High-Performance Power Clamping System Maxi|GRIP

## The FAHRION Precision Collet

The heart of the technology is the collet: For many years, the combination of a specially manufactured steel and our unique production technology has enabled FAHRION to manufacture top-quality collets according to DIN ISO15488 (ER/ESX) in an outstanding quality with a maximum accuracy of 2  $\mu\text{m}$ .

## The FAHRION CENTRO|P Precision Collet Chuck

The CENTRO|P's legendary reputation on the market is no coincidence. It is one of the best collet chucks that money can buy. Combined with the FAHRION collets, which are perfectly

matched to this chuck, it achieves a system accuracy of 3  $\mu\text{m}$  and avoids the need to use expensive hydraulic expansion and shrinking techniques.

## The FAHRION SYNCHRO|T Tapping Chuck

By compensating the pitch differences or tolerances of the tap and the synchronous spindle, the machining results can be optimised while maintaining quality and cost-effectiveness. A special tapping chuck with minimum length compensation is required for this.

## Even more Power with the Maxi|GRIP High Performance Power Clamping System

In order to be able to use the CENTRO|P clamping technology for extreme roughing and highly resistant materials as well, this simple but technically ingenious clamping technology increases the holding torque of the CENTRO|P to 800 Nm and more.

**Find more information about the complete FAHRION programme at [www.fahrion.de](http://www.fahrion.de)**



# Precision Collets GERC-B DIN ISO 15488-B (ER/ESX)

**Concentricity and repeatability:** Concentricity see (☒) in chart/repeatability 5 µm

**Application:** For HSC and for high precision work  
**Collapse:** Nominal size reduced by T



GERC8-B:

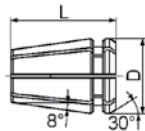

GERC11-B to GERC40-B:

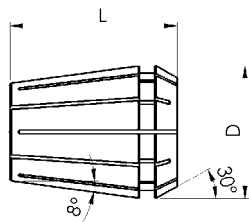

## Precision Collets GERC-B - 5 µm for types GERC11-B to GERC40-B

E-No. Description	Order-No.	☒	T	D	L	Profile	from-to	steps
④ 4004E GERC8-B *	1371001	10 µm	-0,5	8,5	13,6	●	1,0-5,0	0,5
	1371004						1/16"•1/8"•3/16"	
④ 4008E GERC11-B	1371101	5 µm	-0,5	11,3	18	●	1,0-7,0	0,5
	1371104						1/16"•3/32"•1/8"•5/32"•3/16"•7/32"•1/4"	
④ 426E GERC16-B	1371301	5 µm	-0,5	17	27,5	●	1,0-2,0	0,5
	1371304		-1,0				2,5-10,0	0,5
④ 428E GERC20-B	1371401	5 µm	-0,5	21	31,5	●	1,0-2,0	0,5
	1371404		-1,0				2,5-13,0	0,5
④ 430E GERC25-B	1371501	5 µm	-0,5	26	34	●	1,0-2,0	0,5
	1371504		-1,0				2,5-16,0	0,5
④ 470E GERC32-B	1371601	5 µm	-1,0	33	40	●	1/8"•3/16"•1/4"•5/16"•3/8"•7/16"•1/2"•9/16"•5/8"	1,0
	1371604						1/8"•3/16"•1/4"•5/16"•3/8"•7/16"•1/2"•9/16"•5/8"•11/16"•3/4"•13/16"	1,0
④ 472E GERC40-B	1371701	5 µm	-1,0	41	46	●	3,0-26,0	0,5
	1371704						1/8"•3/16"•1/4"•5/16"•3/8"•7/16"•1/2"•9/16"•5/8"•11/16"•3/4"•13/16"•7/8"•1"	1,0

\* GERC8-B is not included in the DIN/ISO-standard

## Precision Collets GERC-B in Wooden Boxes



E-No. Description	Order-No.	Set	☒	Profile	Content of set from-to	steps
④ 4004E GERC8-B	1371016	9 pieces	10 µm	●	1,0-5,0	0,5
④ 4008E GERC11-B	1371116	13 pieces	5 µm	●	1,0-7,0	0,5
④ 426E GERC16-B	1371316	10 pieces	5 µm	●	1,0-10,0	1,0
④ 428E GERC20-B	1371416	12 pieces	5 µm	●	2,0-13,0	1,0
④ 430E GERC25-B	1371516	15 pieces	5 µm	●	2,0-16,0	1,0
④ 470E GERC32-B	1371616	18 pieces	5 µm	●	3,0-20,0	1,0
④ 472E GERC40-B	1371716	23 pieces	5 µm	●	4,0-26,0	1,0

**Ordering examples:**

430E GERC25-B ● 6,0 mm = Order-No. 13715010600  
 470E GERC32-B 18 pieces = Order-No. 1371616

# Precision Collets GERC-BD similar to DIN ISO 15488-A



**Concentricity and repeatability:** Concentricity see (⊠) in chart/repeatability 5 μm

**Application:** For inner coolant supply

**Collapse:** h8, i.e. only nominal size can be clamped

**Special features:** With seals for inner coolant supply (can be used up to 120 bar)

**Remark:** Shafts with lateral flat can be used under certain circumstances, i.e. the flat must be behind the rubber seals in order to reach a complete sealing

## Precision Collets GERC-BD with Seals for IC (Inner Coolant Supply) - 5 μm

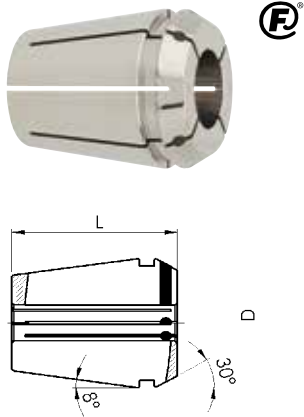

E-No. Description	Order-No.	⊠	T	D	L	Profile	from-to	steps
Ⓢ 4012E GERC11-BD	1372101	5 μm	h8	11,2	18	●	3,0-6,0	1,0
	1372104						1/8"•3/16"•1/4"	
Ⓢ 425E GERC16-BD	1372301			16,7	27,5	●	3,0-10,0	1,0
	1372304						1/8"•3/16"•1/4"•5/16"•3/8"	
	1372401						3,0-12,0	1,0
Ⓢ 427E GERC20-BD	1372404			20,7	31,5	●	1/8"•3/16"•1/4"•5/16"•3/8"•7/16"•1/2"	
Ⓢ 429E GERC25-BD	1372501			25,7	34	●	3,0-16,0	1,0
	1372504						1/8"•3/16"•1/4"•5/16"•3/8"•7/16"•1/2"•9/16"•5/8"	
Ⓢ 469E GERC32-BD	1372601			32,7	40	●	3,0-20,0	1,0
	1372604						1/8"•3/16"•1/4"•5/16"•3/8"•7/16"•1/2"•9/16"•5/8"•3/4"	
Ⓢ 471E GERC40-BD	1372701	40,7	46	●	6,0•8,0•10,0•12,0•14,0•16,0•18,0•20,0•22,0•25,0			

## Precision Collets GERC-BD with Seals for IC in Wooden Boxes



E-No. Description	Order-No.	Set	⊠	Profile	Content of set from-to
Ⓢ 425E GERC16-BD	13723160060	6 pieces	5 μm	●	3,0•4,0•5,0•6,0•8,0•10,0
Ⓢ 427E GERC20-BD	13724160070	7 pieces		●	3,0•4,0•5,0•6,0•8,0•10,0•12,0
Ⓢ 429E GERC25-BD	13725160070	7 pieces		●	4,0•6,0•8,0•10,0•12,0•14,0•16,0
Ⓢ 469E GERC32-BD	13726160080	8 pieces		●	4,0•6,0•8,0•10,0•12,0•14,0•16,0•20,0

**Use of shanks with lateral flat with GERC-BD**

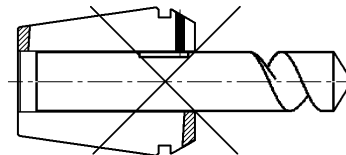

Incorrect position!

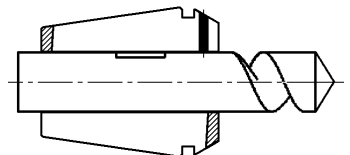

Correct position!

### Ordering examples:

427E GERC20-BD ● 11,0 mm = Order-No. 13724011100

427E GERC20-BD 7 pieces = Order-No. 13724160070



# Precision Collets GERC-HP DIN ISO 15488-B (ER/ESX)

**Concentricity and repeatability:** Average of 3 µm (exception see chart (☒)) checked in the Precision Collet Chuck CENTROJP at a distance of 3xD (max. 50 mm)

**Application:** For HSC and high precision work with FAHRION Precision Collets Chucks CENTROJP

**Collapse:** h10 in CENTROJP (no collapse as this has a negative effect on the concentricity) • Nominal size reduced by T in standard collet chucks

**Special features:** Coloured ring only for identification (no sealing function)



GERC8-HP:

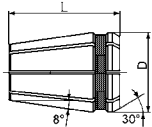

GERC11-HP to GERC40-HP:

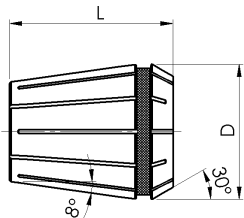

Precision Collets GERC-HP - 2 µm for types GERC11-HP to GERC40-HP

E-No. Description	Order-No.	☒	T	D	L	Profile	from-to	steps
☒ 4004E GERC8-HP *	1361001	5 µm	-0,5	8,5	13,6	●	1,0-5,0	0,5
	1361004						1/16"•1/8"•3/16"	
	1361101						1,0-7,0	0,5
☒ 4008E GERC11-HP	1361104	2 µm	-0,5	11,3	18	●	1/16"•3/32"•1/8"•5/32"•3/16"•7/32"•1/4"	
☒ 426E GERC16-HP	1361301	2 µm	-0,5	17	27,5	●	1,0-2,0	0,5
			-1,0				2,5-10,0	0,5
			-0,5				1,1-1,4•1,6-1,9	0,1
	-1,0		2,1-2,4•2,6-2,9•3,1-3,4•3,6-3,8				0,1	
	-1,0		5,6•6,3•7,1					
	-0,5		1/16"•3/32"					
1361304		-1,0			●	1/8"•5/32"•3/16"•7/32"•1/4"•9/32"•5/16"•11/32"•3/8"		
☒ 428E GERC20-HP	1361401	2 µm	-0,5	21	31,5	●	1,0-2,0	0,5
	1361404		-1,0				2,5-13,0	0,5
☒ 430E GERC25-HP	1361501	2 µm	-0,5	26	34	●	1,0-2,0	0,5
	1361504		-1,0				2,5-16,0	0,5
								1/8"•3/16"•1/4"•5/16"•3/8"•7/16"•1/2"•9/16"•5/8"
☒ 470E GERC32-HP	1361601	2 µm	-1,0	33	40	●	2,0-20,0	0,5
	1361604							1/8"•3/16"•1/4"•5/16"•3/8"•7/16"•1/2"•9/16"•5/8"•11/16"•3/4"
☒ 472E GERC40-HP	1361701	2 µm	-1,0	41	46	●	3,0-26,0	0,5
	1361704							1/8"•3/16"•1/4"•5/16"•3/8"•7/16"•1/2"•9/16"•5/8"•11/16"•3/4"•13/16"•7/8"•1"

\* GERC8-HP is not included in the DIN/ISO-standard

Precision Collets GERC-HP in Wooden Boxes



E-No. Description	Order-No.	Set	☒	Profile	Content of set
☒ 426E GERC16-HP	13613160060	6 pieces	2 µm	●	3,0•4,0•5,0•6,0•8,0•10,0
☒ 428E GERC20-HP	13614160070	7 pieces	2 µm	●	3,0•4,0•5,0•6,0•8,0•10,0•12,0
☒ 430E GERC25-HP	13615160070	7 pieces	2 µm	●	4,0•6,0•8,0•10,0•12,0•14,0•16,0
☒ 470E GERC32-HP	13616160080	8 pieces	2 µm	●	4,0•6,0•8,0•10,0•12,0•14,0•16,0•20,0

**Ordering examples:**

470E GERC32-HP ● 12,0 mm = Order-No. 13616011200

470E GERC32-HP 8 pieces = Order-No. 13616160080

# Precision Collets GERC-HPD similar to DIN ISO 15488-A



**Concentricity and repeatability:** Average of 3 µm in the Precision Collet Chucks CENTROJP at a distance of 3xD (max. 50 mm)

**Application:** For inner coolant supply when HSC machining and high precision machining when used in CENTROJP

**Collapse:** h8, i.e. only nominal size can be clamped

**Special features:** With seals for inner coolant supply (can be used up to 120 bar) • coloured ring only for identification (no sealing function)

**Remark:** Shafts with lateral flat can be used under certain circumstances, i.e. the flat must be behind the rubber seals in order to achieve a complete sealing

## Precision Collets GERC-HPD with Seals for IC (Inner Coolant Supply) - 2 µm

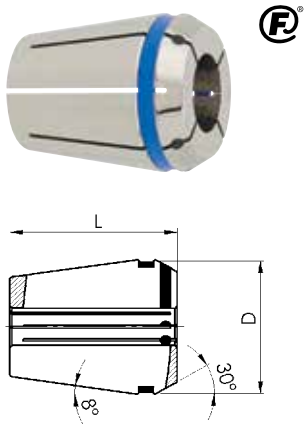

E-No. Description	Order-No.	↗	T	D	L	Profile	from-to	steps
Ⓡ 4012E GERC11-HPD	1362101	2 µm	h8	11,2	18	●	3,0-6,0	1,0
	1362104					●	1/8"•3/16"•1/4"	
Ⓡ 425E GERC16-HPD	1362301			16,7	27,5	●	3,0-10,0	1,0
	1362304					●	1/8"•3/16"•1/4"•5/16"•3/8"	
	1362401					●	3,0-12,0	1,0
Ⓡ 427E GERC20-HPD	1362404			20,7	31,5	●	1/8"•3/16"•1/4"•5/16"•3/8"•7/16"•1/2"	
	1362501					●	3,0-16,0	1,0
Ⓡ 429E GERC25-HPD	1362504			25,7	34	●	1/8"•3/16"•1/4"•5/16"•3/8"•7/16"•1/2"•9/16"•5/8"	
	1362601					●	3,0-20,0	1,0
Ⓡ 469E GERC32-HPD	1362604			32,7	40	●	1/8"•3/16"•1/4"•5/16"•3/8"•7/16"•1/2"•9/16"•5/8"•11/16"•3/4"	
	1362701					●	6,0•8,0•10,0•12,0•14,0•16,0•18,0•20,0•22,0•25,0	
Ⓡ 471E GERC40-HPD	1362704			40,7	46	●	1/4"•3/8"•1/2"•5/8"•3/4"•1"	

## Precision Collets GERC-HPD in Wooden Boxes



E-No. Description	Order-No.	Set	↗	Profile	Content of set
Ⓡ 425E GERC16-HPD	13623160060	6 pieces	2 µm	●	3,0•4,0•5,0•6,0•8,0•10,0
Ⓡ 427E GERC20-HPD	13624160070	7 pieces		●	3,0•4,0•5,0•6,0•8,0•10,0•12,0
Ⓡ 429E GERC25-HPD	13625160070	7 pieces		●	4,0•6,0•8,0•10,0•12,0•14,0•16,0
Ⓡ 469E GERC32-HPD	13626160080	8 pieces		●	4,0•6,0•8,0•10,0•12,0•14,0•16,0•20,0

### Ordering examples:

469E GERC32-HPD ● 16,0 mm = Order-No. 13626011600

469E GERC32-HPD 8 pieces = Order-No. 13626160080





# Precision Collets GERC-HPDD similar to DIN ISO 15488-A

**Concentricity and repeatability:** Average of 3 µm in the Precision Collet Chucks CENTROJP at a distance of 3xD (max. 50 mm)

**Application:** For inner coolant supply when HSC machining and high precision machining when used in CENTROJP

**Collapse:** h8, i.e. only nominal size can be clamped

**Special features:** With seals for inner coolant supply (can be used up to 120 bar) and additional jet holes in order to bring the coolant to the cutting edge in tools without coolant channel • coloured ring only for identification (no sealing function)

**Remark:** Shafts with lateral flat can be used under certain circumstances, i.e. the flat must be behind the rubber seals in order to achieve a complete sealing

Precision Collets GERC-HPDD with Seals for IC (Inner Coolant Supply) and Jet Holes - 2 µm

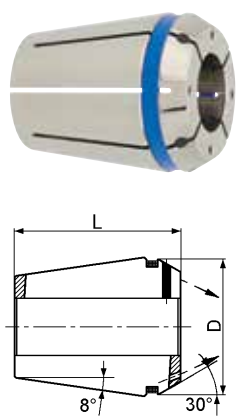

E-No. Description	Order-No.	↗	T	D	L	Profile	from-to
Ⓡ 425E GERC16-HPDD	1363301	2 µm	h8	16,7	27,5	●	4,0•6,0•8,0
	1363304						1/8"•1/4"
Ⓡ 427E GERC20-HPDD	1363404			20,7	31,5	●	1/8"•1/4"•3/8"
	Ⓡ 429E GERC25-HPDD			1363501	25,7	34	●
1363504				1/8"•1/4"•3/8"•1/2"			
Ⓡ 469E GERC32-HPDD	1363601			32,7	40	●	4,0•6,0•8,0•10,0•12,0•14,0•16,0•18,0•20,0
	1363604						1/8"•1/4"•3/8"•1/2"•5/8"•3/4"
Ⓡ 471E GERC40-HPDD	1363701			40,7	46	●	10,0•12,0•14,0•16,0•18,0•20,0•25,0
	1363704						1/2"•5/8"•3/4"•1"

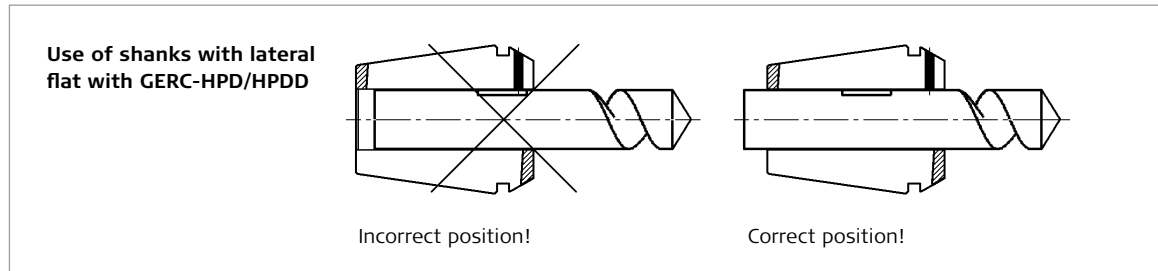

**Ordering example:**  
 469E GERC32-HPDD ● 8,0 mm = Order-No. 13636010800

# Precision Collets CER-K2 DIN ISO 15488-B (ER/ESX)

**Concentricity and repeatability:** Concentricity for DIN/ISO class 2 see  in chart/repeatability 10 µm

**Application:** Only for such applications where the accuracy and the lifetime of the cutting tool is not important

**Collapse:** Nominal size reduced by T



CER8-K2:

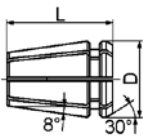

CER11-K2 to CER50-K2:

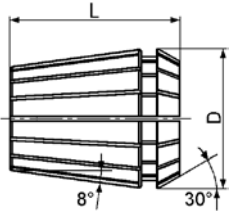

## Precision Collets CER-K2 - 15-20 µm

E-No. Description	Order-No.		T	D	L	Profile	from-to	steps
4004E CER8-K2 *	1321001	15 µm	-0,5	8,5	13,5	●	1,0-5,0	0,5
4008E CER11-K2	1321101	15 µm	-0,5	11,5	18	●	1,0-7,0	0,5
					15	●	7,5-8,0 *	0,5
426E CER16-K2	1321301	15 µm	-0,5	17	27,5	●	1,0-2,0	1,0
						●	3,0-10,0	1,0
					21,7	●	11,0-12,0 *	1,0
428E CER20-K2	1321401	15 µm	-0,5	21	31,5	●	1,0-2,0	1,0
						●	3,0-13,0	1,0
		20 µm	-1,0	31	●	14,0 *		
				27,5	●	15,0 *		
430E CER25-K2	1321501	15 µm	-0,5	26	34	●	2,0	
						●	3,0-16,0	1,0
		20 µm	-1,0	33	●	17,0 *		
				31	●	18,0 *		
				28	●	19,0 *		
470E CER32-K2	1321601	15 µm	-1,0	33	40	●	2,0-2,5	0,5
		20 µm				●	3,0-20,0	1,0
472E CER40-K2	1321701	15 µm	-1,0	41	46	●	21,0 *	
		20 µm				●	3,0-26,0	1,0
477E CER50-K2	1321801	15 µm	-2,0	52	60	●	27,0-30,0	1,0
		20 µm				●	6,0-10,0	2,0
						●	12,0-34,0	2,0

\* CER8-K2, CER12-K2, CER50-K2 and short executions are not included in the DIN/ISO-standard

## Precision Collets CER-K2 in Wooden Boxes



E-No. Description	Order-No.	Set		Profile	Content of set from-to	steps
4008E CER11-K2	1321118	13 pieces	15 µm	●	1,0-7,0	0,5
426E CER16-K2	1321318	10 pieces		●	1,0-10,0	1,0
428E CER20-K2	1321418	12 pieces	15-20 µm	●	2,0-13,0	1,0
430E CER25-K2	1321518	15 pieces		●	2,0-16,0	1,0
470E CER32-K2	1321618	18 pieces		●	3,0-20,0	1,0
472E CER40-K2	1321718	23 pieces		●	4,0-26,0	1,0

### Ordering examples:

426E CER16-K2 ● 8,0 mm = Order-No. 13213010800

426E CER16-K2 10 pieces = Order-No. 1321318



# Tap Collets GERC-GBD similar to DIN ISO 15488-A

**Concentricity and repeatability:** Concentricity see in chart/repeatability 6 µm

**Application:** For Tapping

**Collapse:** h8, i.e. only nominal size can be clamped

**Special features:** With internal square drive without axial compensation • with seals for inner coolant supply (can be used up to 120 bar)

**Remark:** Chart with tap shank dimensions DIN and ISO see pages 46 and 47 in the appendix • for the same shank-Ø the DIN as well as the ISO taps can be used

Tap Collets GERC-GBD with Internal Square Drive and Seals for IC (Inner Coolant Supply) - 10 µm

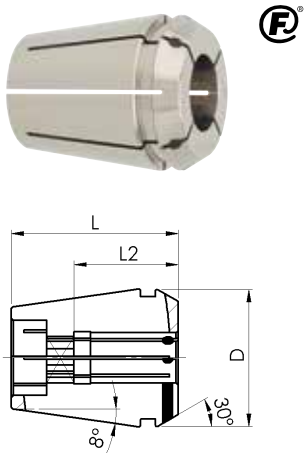

E-No. Description	Order-No.		D	L	L2	Profile	Standard bore (shank-Ø/square)
® 4031E GERC16-GBD	1382301	10 µm	16,7	27,5	18	●/■	2,8/2,1
						●/■	3,5/2,7•4,0/3,2•4,5/3,55•5,0/4,0•5,5/4,5•6,0/5,0•6,3/5,0•7,0/5,6•7,1/5,6
					22	●/■	8,0/6,3•9,0/7,1
® 4276E GERC20-GBD	1382401	10 µm	20,7	31,5	18	●/■	3,5/2,7•4,0/3,2•4,5/3,55•5,0/4,0•5,5/4,5•6,0/5,0•6,3/5,0•7,0/5,6•7,1/5,6
						22	●/■
					25	●/■	10,0/8,0•11,0/9,0•11,2/9,0•12,0/9,0
® 4282E GERC25-GBD	1382501	10 µm	25,7	34	18	●/■	3,5/2,7•4,0/3,2•4,5/3,55•5,0/4,0•5,5/4,5•6,0/5,0•6,3/5,0•7,0/5,6•7,1/5,6
						22	●/■
					25	●/■	10,0/8,0•11,0/9,0•11,2/9,0•12,0/9,0•12,5/10,0•14,0/11,2•16,0/12,5
® 4537E GERC32-GBD	1382601	10 µm	32,7	40	18	●/■	4,0/3,2•4,5/3,55•5,0/4,0•5,5/4,5•6,0/5,0•6,3/5,0•7,0/5,6•7,1/5,6
						22	●/■
					25	●/■	10,0/8,0•11,0/9,0•11,2/9,0•12,0/9,0•12,5/10,0•14,0/11,2•16,0/12,5
						30	●/■
® 4716E GERC40-GBD	1382701	10 µm	40,7	46	18	●/■	6,0/5,0•6,3/5,0•7,0/5,6•7,1/5,6
						22	●/■
					25	●/■	10,0/8,0•11,0/9,0•11,2/9,0•12,0/9,0•12,5/10,0•14,0/11,2•16,0/12,5
						33	●/■

**Ordering example:**

4276E GERC20-GBD ●/■ 4,0/3,2 mm = Order-No. 13824010400

# Tap Collets GERC-GBDD similar to DIN ISO 15488-A



**Concentricity and repeatability:** Concentricity see  in chart/repeatability 6 µm

**Application:** For Tapping

**Collapse:** h8, i.e. only nominal size can be clamped

**Special features:** With internal square drive without axial compensation • with seals for inner coolant supply (can be used up to 120 bar) and

additional jet holes in order to bring the coolant to the cutting edge in tools without coolant channel

**Remark:** Chart with tap shank dimensions DIN and ISO see pages 46 and 47 in the appendix • for the same shank-Ø the DIN as well as the ISO taps can be used

Tap Collets GERC-GBDD with Internal Square Drive, Seals for IC (Inner Coolant Supply) and Jet Holes - 10 µm

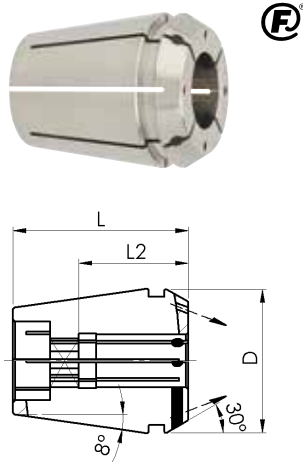

E-No. Description	Order-No.		D	L	L2	Profile	Standard bore (shank-Ø/square)
Ⓢ 4031E GERC16-GBDD	1383301	10 µm	16,7	27,5	18	●/■	3,5/2,7•4,5/3,55•6,0/5,0•7,0/5,6
					22	●/■	8,0/6,3
Ⓢ 4276E GERC20-GBDD	1383401	10 µm	20,7	31,5	18	●/■	4,5/3,55•6,0/5,0•7,0/5,6
					22	●/■	8,0/6,3•9,0/7,1
Ⓢ 4282E GERC25-GBDD	1383501	10 µm	25,7	34	25	●/■	10,0/8,0
					18	●/■	4,5/3,55•6,0/5,0•7,0/5,6
					22	●/■	8,0/6,3•9,0/7,1
Ⓢ 4537E GERC32-GBDD	1383601	10 µm	32,7	40	25	●/■	10,0/8,0•11,0/9,0•12,0/9,0•14,0/11,2
					18	●/■	4,5/3,55•6,0/5,0•7,0/5,6
					22	●/■	8,0/6,3•9,0/7,1
					30	●/■	18,0/14,5•20,0/16,0

**Ordering example:**

4537E GERC32-GBDD ●/■ 9,0/7,1 mm = Order-No. 13836010900

# Tap Collets CET-GB

## similar to DIN ISO 15488-A | Taper Wipers KWK-ER

**Concentricity and repeatability:** Concentricity for DIN/ISO class 2 see  in chart/repeatability 10 µm

**Application:** For Tapping, but not for use with Precision Collet Chucks CENTROJP

**Special features:** Compact and very strong construction • incorporated axial compensation • rational and economic solution for tapping on CNC machines • spring force is adapted to the corresponding tap size

**Remark:** Chart with tap shank dimensions DIN and ISO see pages 46 and 47 in the appendix • for the same shank-Ø the DIN as well as the ISO taps can be used

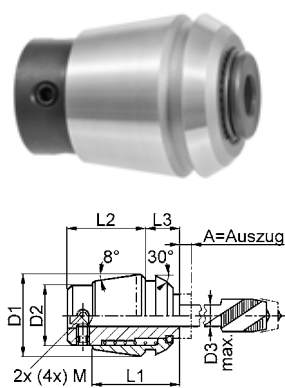

### Tap Collets CET-GB with Incorporated Axial Compensation - 15-20 µm

E-No. Description	Order-No.		Profile	Standard bore
4013E CET11-GB	1336101	15 µm	●	2,2•2,5•2,8•3,0•3,5
4033E CET16-GB	1336301	15 µm	●	2,2•2,5•2,8•3,0•3,5•4,0•4,5•5,0•5,5•6,0•6,3
4284E CET20-GB	1336401	15 µm	●	2,2•2,5•2,8•3,0•3,5•4,0•4,5•5,0•5,5•6,0•6,3•7,0
4285E CET25-GB	1336501	15 µm	●	2,5•2,8•3,0•3,5•4,0•4,5•5,0•5,5•6,0•6,3•7,0•7,1•8,0•9,0•10,0
4538E CET32-GB	1336601	15 µm	●	4,5•5,0•5,5•6,0•6,3•7,0•7,1•8,0•9,0•10,0
		20 µm	●	11,0•11,2•12,0•12,5
4717E CET40-GB	1336701	15 µm	●	6,0•6,3•7,0•7,1•8,0•9,0•10,0
		20 µm	●	11,0•11,2•12,0•12,5•14,0•16,0

### Technical Data

Description	A	D1	D2	D3 max.	L1	L2	L3
CET11-GB	5,5	11,5	7	3,55	18	16,5	5
CET16-GB	7	17	11	6,3	22	20	7
CET20-GB	7	21	14	7,1	24	23	8
CET25-GB	8	26	19	10	26	24	10
CET32-GB	10	33	23	12,5	33	32	11
CET40-GB	13	41	28	17	42	42	12

### Operating instructions:

The tapping collets have an extension stroke, but no compression stroke.

They are made with a plain external body, one bored sleeve to hold the tap shank, 2 or 4 clamping screws on the tap square and one return spring.

On CNC machines the following tapping process is recommended: Fast approach then tapping feed from 95 to 99% of the pitch value so as to be in the compensation stroke when spindle rotation and feed movement are simultaneously reversed. Use standard canned cycles.

### Taper Wipers KWK-ER for Collet Closing Tapers DIN ISO 15488 (ER/ESX)



Description	Order-No.	for Collet Closing Tapers
KWK-ER11	2220100	CP11M•CPC11M•HFER11
KWK-ER16	2220200	CP16•CPC16•CP16M•ST16-GB•HFER16
KWK-ER20	2220300	CP20•ST20-GB•HFER20
KWK-ER25	2220400	CP25•ST25-GB•NCER25•HFER25
KWK-ER32	2220500	CP32•ST32-GB•NCER32•HFER32

### Ordering examples:

4717E CET40-GB ● 9,0 mm = Order-No. 13367010900

KWK-ER25 = Order-No. 2220400

# Clamping Nuts and Sealing Discs for Precision Collets DIN ISO 15488 (ER/ESX)

**Concentricity and repeatability:** Extremely high due to the fact that the thread and taper are ground in one operation

**Application:** For all collet chucks, collet holders and acceptances DIN ISO 15488 (ER/ESX)

**Special features:** Are indicated at every specific type

**EasyClick:** All types of clamping nuts with remark EasyClick are manufactured in this execution • offers better balance compensation for higher speed and an optical engaging feature (see also page 45)

**Execution type B:** All Clamping Nuts with appendix B are more tenacious and harder because of a special heat treatment • unchanged mass, protection against corrosion and lower friction are additional advantages compared to the competition • the low friction takes effect in the thread as well as at the 30° cone of the collet and results in an approx. 50% higher clamping force

**Remark:** Other executions, e.g. Clamping Nuts with External Thread (also for Sealing Discs DI), are available on request

## Clamping Nuts STMD with hexagon head

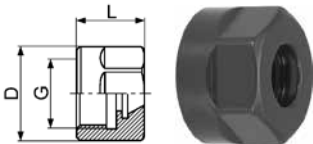

Description	Order-No.	max. torque	max. r.p.m	D	L	G
STM11D-B	2240100	25 Nm	40.000	19	12	M14x0,75
STM16D-B	2240200	50 Nm	40.000	28	18	M22x1,5
STM20D-B	2240300	75 Nm	40.000	34	19,5	M25x1,5

**Execution:** With EasyClick and hexagon head (form D) • case-hardened (660 HV10) and burnished

**Special features:** All collets with outside form DIN ISO 15488 can be clamped

## Clamping Nuts STME with six slots

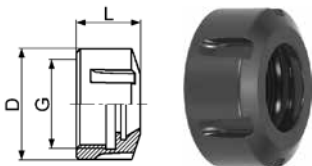

Description	Order-No.	max. torque	max. r.p.m	D	L	G
STM16E-B	2241200	50 Nm	40.000	32	18	M22x1,5
STM20E-B	2241300	75 Nm	40.000	35	19	M25x1,5
STM25E-B	2241400	85 Nm	35.000	42	21	M32x1,5
STM32E-B	2241500	105 Nm	35.000	50	23	M40x1,5
STM40E-B	2241600	150 Nm	25.000	63	26	M50x1,5
STM50E-B	2241700	200 Nm	15.000	78	35	M64x2

**Execution:** With EasyClick and six slots (form E) • case-hardened (660 HV10) and burnished

**Special features:** All collets with outside form DIN ISO 15488 can be clamped

### Ordering example:

STM25E-G-B = Order-No. 2241400

## Clamping Nuts and Sealing Discs for Precision Collets DIN ISO 15488 (ER/ESX)

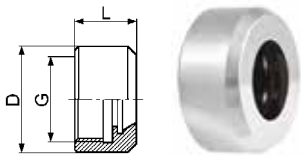
**Clamping Nuts STM without slots**

Description	Order-No.	max. torque	max. r.p.m	D	L	G
STM16-B	2244200	50 Nm	50.000	30	18	M22x1,5
STM20-B	2244300	75 Nm	45.000	32	19	M25x1,5
STM25-B	2244400	85 Nm	40.000	40	21	M32x1,5
STM32-B	2244500	105 Nm	40.000	50	23	M40x1,5
STM40-B	2244600	150 Nm	30.000	63	26	M50x1,5

**Execution:** With EasyClick without slots • case-hardened (660 HV10)

**Special features:** All collets with outside form DIN ISO 15488 can be clamped

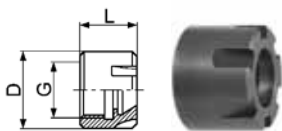
**Mini Clamping Nuts STMM**

Description	Order-No.	max. torque	max. r.p.m	D	L	G
STM8M-B	2245000	8 Nm	80.000	12	11	M10x0,75
STM11M-B	2245100	18 Nm	70.000	16	12	M13x0,75
STM16M-B	2245200	28 Nm	60.000	22	18	M19x1
STM20M-B	2245300	35 Nm	50.000	28	19,5	M24x1
STM25M-B	2245400	40 Nm	40.000	35	21	M30x1

**Execution:** Extremely small external dimensions • case-hardened (540 HV10)

**Application:** Mainly used in multi-spindle drilling heads and cylindrical collet holders

**Special features:** Ground all over • all collets with outside form DIN ISO 15488 can be clamped

**Remark:** Not interchangeable with clamping nuts DIN ISO 15488 (different thread)

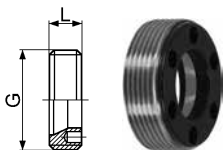
**Clamping Nuts STM-A with external thread**

Description	Order-No.	max. torque	max. r.p.m	L	G
STM11A	2266100	24 Nm	30.000	6	M18x1
STM16A	2266200	35 Nm	30.000	8	M24x1
STM20A	2266300	40 Nm	25.000	11	M28x1,5
STM25A	2266400	46 Nm	25.000	12,5	M32x1,5
STM32A	2266500	60 Nm	20.000	14	M40x1,5

**Execution:** With External Thread • case-hardened (660 HV10) and burnished

**Application:** In recessed collet mounts, such as driven tools, floating bushes and all space saving constructions

**Special features:** All collets with outside form DIN ISO 15488 can be clamped

**Remark:** Not interchangeable with clamping nuts DIN ISO 15488 (external thread)

**Ordering example:**

STM20-B = Order-No. 2244300

# Clamping Nuts and Sealing Discs for Precision Collets DIN ISO 15488 (ER/ESX)



Clamping Nuts STME-DI with six slots for Sealing Discs DI

Description	Order-No.	max. torque	max. r.p.m	D	L	G
STM16E-DI-B	2242200	50 Nm	40.000	32	22	M22x1,5
STM20E-DI-B	2242300	75 Nm	40.000	35	23,2	M25x1,5
STM25E-DI-B	2242400	85 Nm	35.000	42	24,7	M32x1,5
STM32E-DI-B	2242500	105 Nm	35.000	50	27	M40x1,5
STM40E-DI-B	2242600	150 Nm	25.000	63	30,7	M50x1,5

**Execution:** With EasyClick and six slots (form E) • case-hardened (660 HV10) and burnished

**Special features:** Can be used up to 80 bar with sealing discs DI • reasonable alternative compared to other sealing systems • all collets with outside form DIN ISO 15488 can be clamped

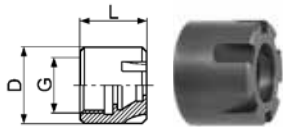

Mini Clamping Nuts STMM-DI for Sealing Discs DI

Description	Order-No.	max. torque	max. r.p.m	D	L	G
STM16M-DI-B	2246200	28 Nm	60.000	22	22	M19x1
STM20M-DI-B	2246300	35 Nm	50.000	28	23,2	M24x1
STM25M-DI-B	2246400	40 Nm	40.000	35	24,7	M30x1

**Execution:** Extremely small external dimensions • case-hardened (540 HV10)

**Application:** Mainly used in multi-spindle drilling heads and cylindrical collet holders

**Special features:** Can be used up to 80 bar with sealing discs DI • reasonable alternative compared to other sealing systems • ground all over • all collets with outside form DIN ISO 15488 can be clamped

**Remark:** Not interchangeable with clamping nuts DIN ISO 15488 (different thread)

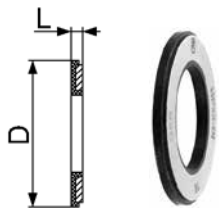

Sealing Discs DI

Description	Order-No.	D	L	Profile	from-to	steps	range
DI16	2430301	12,6	2	●	1,0-10,0	0,5	+0,4/-0,1
	2430304				1/8"•3/16"•1/4"•5/16"•3/8"		
DI20	2440301	15,8	2	●	2,0-13,0	0,5	+0,4/-0,1
DI25	2450301	20,2	2	●	2,0-16,0	0,5	+0,4/-0,1
	2460301				2,0-20,0		
DI32	2460301	26,2	2	●	1/8"•3/16"•1/4"•5/16"•3/8"•1/2"•5/8"•3/4"	0,5	+0,4/-0,1
	2460304						
DI40	2470301	34,2	2	●	3,0-30,0	0,5	+0,4/-0,1
	2470304				1/8"•3/16"•1/4"•5/16"•3/8"•1/2"•5/8"•3/4"•7/8"•1"		

**Execution:** Sealing disc can be used up to 80 bar

**Ordering examples:**

STM20-M-DI = Order-No. 2246300

DI32 ● 12,0 mm = Order-No. 24603011200



## Wrenches for Clamping Nuts DIN ISO 15488 (ER/ESX)



### Roller Bearing Wrenches RO with handle

Description	Order-No.	D	for Clamping Nuts
ROD10	4996200	10	HPC8M
RO16	4990400	16	STM11M•HPC11M+DI
RO22	4990500	22	STM16M+DI•HPC16MS+DI
RO24	4990600	24	HPC16M+DI•HPC16C+DI
RO30	4990800	30	STM16•HPC16+DI•CP16-HSS+DI
RO32	4991000	32	STM16E+DI•STM20•HPC20+DI•CP20-HSS+DI
RO35	4991200	35	STM20E+DI•STM25M+DI
RO40	4991400	40	STM25•HPC25+DI•CP25-HSS+DI
RO42	4991600	42	STM25E+DI
RO50	4991800	50	STM32•STM32E+DI•HPC32+DI•CP32-HSS+DI•HPC225+DIG
RO63	4992000	63	STM40•STM40E+DI•HPC40+DI•CP40-HSS+DI•HPC432+DIG

**Special features:** With standard handle

**Remark:** The OD of the clamping nuts must be produced within the DIN tolerances



### Roller Bearing Heads DRO

Description	Order-No.	D	VKT	for Clamping Nuts
DRO16	4993400	16	9x12	STM11M•HPC11M+DI
DRO22	4993500	22	9x12	STM16M+DI•HPC16MS+DI
DRO24	4993600	24	9x12	HPC16M+DI•HPC16C+DI
DRO30	4993800	30	9x12	STM16•HPC16+DI•CP16-HSS+DI
DRO32	4994000	32	9x12	STM16E+DI•STM20•HPC20+DI•CP20-HSS+DI
DRO35	4994200	35	9x12	STM20E+DI•STM25M+DI
DRO40	4994400	40	14x18	STM25•HPC25+DI•CP25-HSS+DI
DRO42	4994600	42	14x18	STM25E+DI
DRO50	4994800	50	14x18	STM32•STM32E+DI•HPC32+DI•CP32-HSS+DI•HPC225+DIG
DRO63	4995000	63	14x18	STM40•STM40E+DI•HPC40+DI•CP40-HSS+DI•HPC432+DIG

**Special features:** With square drive adapter for a defined clamping of the Clamping Nut by means of a Torque Setting Wrench

**Remark:** The OD of the clamping nuts must be produced within the DIN tolerances



### Torque Setting Wrenches DRMO

Description	Order-No.	VKT	Torque range	for Roller Bearing Heads
DRMO-10-100	4490400	9x12	10-100 Nm	DRO16•DRO22•DRO24•DRO30•DRO32•DRO35
DRMO-20-200	4490600	14x18	20-200 Nm	DRO40•DRO42•DRO50•DRO63
DRMO-60-300	4490800	14x18	60-300 Nm	DRO63 (for CP432DG)

**Application:** For a defined clamping of the Clamping Nut by a pre-set torque

**Special features:** Adjustable by clear scale on the handle • on reaching the set torque value the wrench triggers audibly and by touch

**Ordering example:**

DRMO-20-200 = Order-No. 4490600

# Wrenches for Clamping Nuts DIN ISO 15488 (ER/ESX)

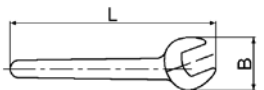

## Wrenches SCHL-SW for Clamping Nuts with hexagon head

Description	Order-No.	L	B	for Clamping Nuts
SCHL-SW17	2280100	155	38	STM11D
SCHL-SW25	2280200	218	53	STM16D
SCHL-SW30	2280300	265	61	STM20D

**Application:** For clamping nuts DIN ISO 15488-D with hexagon head (form D)

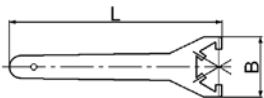

## Wrenches SCHL-E for Clamping Nuts with six slots

Description	Order-No.	L	B	for Clamping Nuts
SCHL-STM16E	2281200	163	50	STM16E
SCHL-STM20E	2281300	180	60	STM20E
SCHL-STM25E	2280400	210	65	STM25E
SCHL-STM32E	2280500	253	75	STM32E
SCHL-STM40E	2280600	290	88	STM40E
SCHL-STM50E	2280700	350	110	STM50E

**Application:** For clamping nuts DIN ISO 15488-D and six slots (form E)

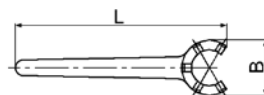

## Wrenches SCHL-M for Mini Clamping Nuts

Description	Order-No.	L	B	for Clamping Nuts
SCHL-STM8M	2282000	76	13	STM8M
SCHL-STM11M	2282100	95,5	17	STM11M
SCHL-STM16M	2282200	117	22,5	STM16M
SCHL-STM20M	2282300	128	28	STM20M
SCHL-STM25M	2282400	145	36	STM25M

**Application:** For mini nuts



## Wrenches SCHL-A for Clamping Nuts with external thread

Description	Order-No.	L	B	for Clamping Nuts
SCHL-STM16A	2284200	140	26	STM16A
SCHL-STM20A	2284300	160	28	STM20A
SCHL-STM25A	2284400	160	32	STM25A
SCHL-STM32A	2284500	180	41	STM32A

**Application:** For clamping nuts with External Thread

### Ordering example:

SCHL-STM11M = Order-No. 2282100

# Precision Collets GOZ-DG and GOZ-DG-HP DIN ISO 10897-B (OZ - double slotted)

The Collets GOZ DIN ISO 10897-B (OZ) are manufactured with the super-finished surface  $\leq 1,6 \mu\text{m}$ .

The advantages of this execution are as follows:  
**improved grip • increased rigidity and clamping force • higher precision and system concentricity • enhanced resistance to corrosion**

**Application:** For HSC and for high precision work  
**Collapse:** Nominal size reduced by T

**Special features:** Double slotted (10 slots up to  $\varnothing 10,0$  mm and 12 slots for larger  $\varnothing$ ) with 0,5 mm collapse for clamping cylindrical shanks and twist drills on their lands

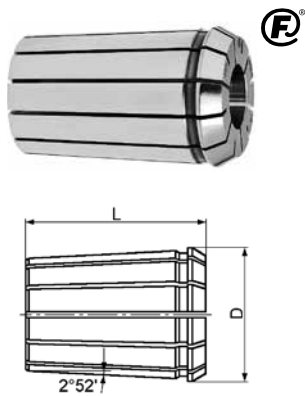

Precision Collets GOZ-DG - 6  $\mu\text{m}$  for types FM16DG and FM25DG

E-No. FM-No.	Order-No.		T	D	L	Profile	from-to	steps
④ 415E FM16DG	1220101	6 $\mu\text{m}$	-0,5	25,5	40	●	2,0-16,0	0,5
	1220104						1/4"•3/8"•1/2"•5/8"	
④ 462E FM25DG	1220201	6 $\mu\text{m}$	-0,5	35,05	52	●	2,0-25,0	0,5
	1220204						1/8"•1/4"•3/8"•1/2"•5/8"•3/4"•1"	
④ 467E FM32DG	1220301	10 $\mu\text{m}$	-0,5	43,7	60	●	4,0-32,0	0,5

**Concentricity and repeatability:** Concentricity see in chart/repeatability 6  $\mu\text{m}$

Precision Collets GOZ-DG-HP - 3  $\mu\text{m}$

E-No. FM-No.	Order-No.		T	D	L	Profile	Standard bore
④ 462E FM25DG-HP	1224201	3 $\mu\text{m}$	-0,5	35,05	52	●	3,0•4,0•6,0•8,0•10,0•12,0•14,0•16,0•18,0•20,0•25,0

**Concentricity and repeatability:** Concentricity see in chart/repeatability 3  $\mu\text{m}$

Precision Collets GOZ-DG in Wooden Boxes



E-No. FM-No.	Order-No.	Set		Profile	Content of set
④ 462E FM25DG	1220216	15 pieces	6 $\mu\text{m}$	●	5,0-16,0/1,0 std. + 18,0•20,0•25,0

**Concentricity and repeatability:** Concentricity see in chart/repeatability 6  $\mu\text{m}$

**Extend of Delivery:** Without milling chuck and clamping wrench

**Ordering examples:**  
 462E FM25DG ● 1/2" = Order-No. 12202041270  
 462E FM25DG 15 pieces = Order-No. 1220216

# Clamping Nuts for Precision Collets DIN ISO 10897 (OZ)

**Concentricity and repeatability:** Extremely high due to the fact that the nuts are ground with the ball bearing ring in one operation  
**Execution:** With slots • case-hardened (660 HV10)

**Application:** For all collet chucks, collet holders and acceptances DIN ISO 10897 (OZ)

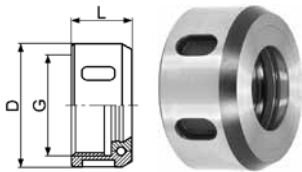

Clamping Nuts KM with Ball Bearing Ring

Description	Order-No.	max. torque	max. r.p.m.	D	L	G
KM216	2150100	85 Nm	25.000	43	24	M33x1,5
KM225	2150200	140 Nm	20.000	60	30	M48x2
KM432	2150300	170 Nm	15.000	72	33,5	M60x2,5

**Special features:** High clamping forces due to ball bearing

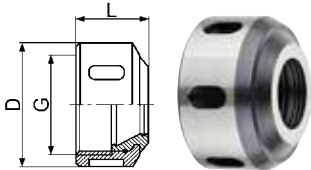

Clamping Nuts KM-DIG with Ball Bearing Ring for Sealing Discs DIG

Description	Order-No.	max. torque	max. r.p.m.	D	L	G
KM225-DIG	2152200	140 Nm	20.000	60	30	M48x2
KM432-DIG	2152300	170 Nm	15.000	72	33,5	M60x2,5

**Special features:** Can be used up to 80 bar with sealing discs DIG • high clamping forces due to ball bearing

**Ordering example:**  
 KM225-DIG = Order-No. 2152200

## Sealing Discs and Wrenches for Clamping Nuts DIN ISO 10897 (OZ)

**Execution:** Sealing disc can be used up to 80 bar

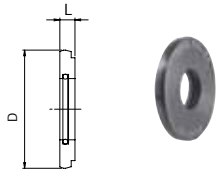

Sealing Discs DIG

Description	Order-No.	D	L	Profile	from-to	steps	range	for Clamping Nuts	for Collets
DIG225 (DS50)	2159201	31	4	●	4,0 – 25,0	1,0	-0,5	KM225-DIG	FM25DG•HP
DIG432 (DS60)	2159301	40		●	4,0 – 32,0			KM432-DIG	FM32DG

**Application:** For Clamping Nuts DIN ISO 10897-D (OZ)

**Special features:** With hook nose DIN 1810-A

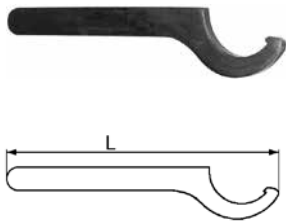

Wrenches SCHL-GR for Clamping Nuts with slots

Description	Order-No.	L	for Clamping Nuts
SCHL-GR.45-50	2140100	206	KM216
SCHL-GR.58-62	2140200	240	KM225•KM225-DIG
SCHL-GR.68-75	2140300	240	KM432•KM432-DIG

**Ordering examples:**

DIG225 (DS50) ● 20,0 mm = Order-No. 21592012000

SCHL-GR-58-62 = Order-No. 2140200

# Precision Collets, Clamping Nuts and Wrenches Rubber-Flex®

**Collapse:** See T in chart

**Special features:** Large capacity for tools with cylindrical shank • Rubber is resistant against coolant and heat up to 100° C

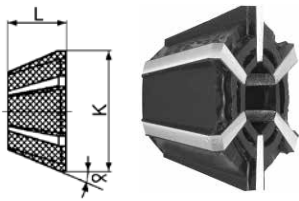

## Precision Collets RFJ Rubber-Flex®

E-No. Description	Order-No.	T	K approx.	L approx.	a	Profile	Clamping capacity
710E RFJ115	1081000	1,5	15	12	13°	●	1,0-2,5
710E RFJ116	1081100	2,0				●	2,5-4,5
710E RFJ117	1081200	3,0				●	4,5-6,5
715E RFJ423	1080100	2,5	23	12,7	20°	●	2,0-4,5
715E RFJ421	1080300	3,0				●	3,5-6,5
715E RFJ420	1080200	3,5				●	4,5-8,0
715E RFJ422	1080400					●	6,5-10,0
750E RFJ444	1080500	2,7	28	16	22°30'	●	1,8-4,5
750E RFJ443	1080600	4,2	30,5			●	2,8-7,0
750E RFJ441	1081300	5,5	31,5			●	4,5-10,0
750E RFJ440	1080700	6,0	32			●	7,0-13,0
750E RFJ445 *	1081400					●	9,0-15,0
750E RFJ445/S1 *	1081600					●	10,0-16,0
766E RFJ460	1081500	4,0	44	19	25°	●	6,0-10,0
766E RFJ461	1080800	6,0				●	10,0-16,0
766E RFJ462	1080900	7,0				●	16,0-23,0

\* can only be used in conjunction with special nut STM44S-RF44

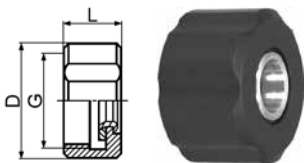

## Clamping Nuts STMRF Rubber-Flex®

Description	Order-No.	D	L	G	for Collets
STM11-RF11	2290200	21	14	M16x1	RF11
STM42-RF42	2290400	31	17	M24x1,5	RF42
STM44-RF44	2290600	40	18	M32x1,5	RF44
STM44S-RF44 *	2290700				

\* all collets RFJ44 can be used in the special nut for RFJ445

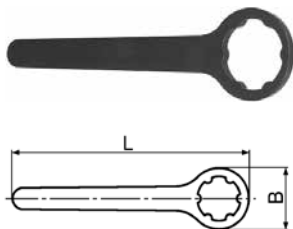

## Wrenches SCHL-STM for Clamping Nuts Rubber-Flex®

Description	Order-No.	B	L	for Clamping Nuts
SCHL-STM11	2292200	30	135	STM11
SCHL-STM42	2292400	42	160	STM42
SCHL-STM44	2292600	54	190	STM44•STM44S

### Ordering example:

750E RFJ443 = Order-No. 1080600

## Split Sleeves with Morse Taper DIN 6329 and DIN 6328

**Application:** For clamping cylindrical twist drills with tangs and counterbores in tool adaptors E-MK (see catalogue page 39), automotive shanks and other Morse taper acceptances

**Collapse:** h7, i.e. only nominal size can be clamped

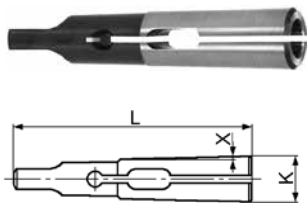

Split Sleeves SL-BO for twist drills

E-No. FM-No.	Order-No.	MK X	K	L	Profile	from-to	steps
511E FM500/1	1050201	1	12,2	65,5	●	3,0-8,0	0,1
514E FM500/2	1050301	2	18	80	●	5,0-13,0	0,1
545E FM500/3	1050401	3	24,1	99	●	8,0-18,0	0,5
548E FM500/4	1050501	4	31,6	124	●	12,0-20,0	1,0
599E FM500/5	1050601	5	44,7	156	●	20,0-36,0	1,0

**Application:** For clamping cylindrical taps with driving square in tap adaptors GE-MK (see catalogue page 40), automotive shanks and other Morse taper acceptances

**Collapse:** h7, i.e. only nominal size can be clamped

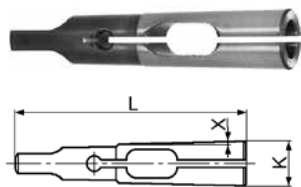

Split Sleeves SL-GB for tap

E-No. FM-No.	Order-No.	MK X	K	L	Profile	Standard bore
501E FM501/1	1051201	1	12,2	65,5	●	2,5•2,8•3,15•3,5•3,55•4,0•4,5•5,0•5,5•5,6•6,0•6,3•7,0•7,1•8,0
504E FM501/2	1051301	2	18	80	●	4,5•5,0•5,5•5,6•6,0•6,3•7,0•7,1•8,0•9,0•9,5•10,0•11,0•11,2•12,0•12,5
535E FM501/3	1051401	3	24,1	99	●	8,0•9,0•9,5•10,0•11,0•11,2•12,0•12,5•14,0•16,0
538E FM501/4	1051501	4	31,6	124	●	12,0•12,5•14,0•16,0•18,0•20,0•22,0•22,4•25,0
589E FM501/5	1051601	5	44,7	156	●	18,0•20,0•22,0•25,0•28,0•30,0•31,5•32,0•36,0

**Ordering example:**

514E FM500/2 ● 11,0 mm = Order-No. 10503011100

# Collet Holders with Morse Taper DIN 228-A for Precision Collets DIN ISO 15488 (ER/ESX) and DIN ISO 10897 (OZ)

**Application:** For holding tools with cylindrical shanks  
**Acceptance:** Morse taper shank with draw-in thread DIN 228-A • tang to modify the holder into execution DIN 228-B see price list  
**Concentricity and repeatability:** Outside taper to collet closing taper  $\leq 5 \mu\text{m}$

**Remark:** Collets, wrenches and nuts as spare parts see pages 13 to 26  
**Extend of Delivery:** With clamping nut DIN ISO 15488 (with hexagon head form D for HFER11 to 20 - rest form E with six slots) and inner stop • without collets and wrenches

Collet Holders HFER-MK

Picture 1

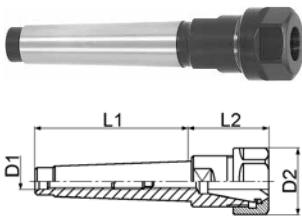

Picture 2

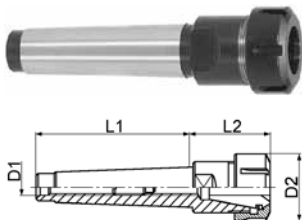

E-No.	Description	Order-No.	Pic.	MK	L1	L2	D1	D2	Precision Collets
HFER16-MK1-M6	2630100	1	1	52,5	41	M6	28	GERC16-B/BD• CER16-K2	
HFER16-MK2-M10	2630200		2	68	42	M10			
HFER16-MK3-M12	2630300		3	85	37	M12			
HFER25-MK2-M10	2650200	2	2	68	47	M10	42	GERC25-B/BD• CER25-K2	
HFER25-MK3-M12	2650300		3	85	28	M12			
HFER32-MK2-M10	2660200	2	2	68	60	M10	50	GERC32-B/BD• CER32-K2	
HFER32-MK3-M12	2660300		3	85	64	M12			
HFER32-MK4-M16	2660400		4	108	54	M16			
HFER32-MK5-M20	2660500	5	136	50	M20				
HFER40-MK3-M12	2670300	2	3	85	64	M12	63	GERC40-B/BD• CER40-K2	
HFER40-MK4-M16	2670400		4	108	75	M16			
HFER40-MK5-M20	2670500		5	136	82	M20			
HFER50-MK4-M16	2680400	2	4	108	96	M16	78	CER50-K2	

**Application:** For holding tools with cylindrical shanks  
**Acceptance:** Morse taper shank with draw-in thread DIN 228-A • tang to modify the holder into execution DIN 228-B see price list  
**Concentricity and repeatability:** Outside taper to collet closing taper  $\leq 5 \mu\text{m}$

**Remark:** Collets, wrenches and nuts as spare parts see pages 27 to 29  
**Extend of Delivery:** With clamping nut DIN ISO 10897 with ball bearing ring • without collets and wrenches

Collet Holders HF-MK

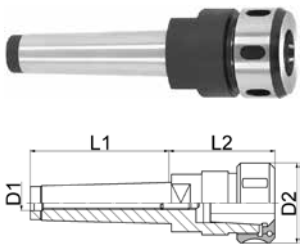

Description	Order-No.	MK	L1	L2	D1	D2	Precision Collets
HF216-MK2-M10	2501200	2	68	65	M10	43	FM16DG
HF216-MK3-M12	2501300	3	85	61	M12		
HF225-MK2-M10	2502200	2	68	76	M10	60	FM25DG
HF225-MK3-M12	2502300	3	85	80	M12		
HF225-MK4-M16	2502400	4	108	84	M16		
HF432-MK4-M16	2503400	4	108	91	M16	72	FM32DG
HF432-MK5-M20	2503500	5	136	85	M20		

**Ordering example:**  
 HFER32-MK3-M12 = Order-No. 2660300



# Collet Holders with Cylindrical Shank for Precision Collets DIN ISO 15488 (ER/ESX)

**Application:** On automatic lathes, capstan lathes and drill extensions for holding tools with cylindrical shanks

**Acceptance:** Cylindrical shank without flat

**Concentricity and repeatability:** Shank O.D. to collet closing taper  $\leq 5 \mu\text{m}$

**Remark:** Collets, wrenches and nuts as spare parts see pages 13 to 26

**Extend of Delivery:** With clamping nut DIN ISO 15488 (with hexagon head form D for HFER11 to 20 - rest form E with six slots) and inner stop (only for executions with internal thread) • without collets and wrenches



Picture 1

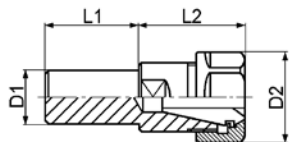

Picture 2

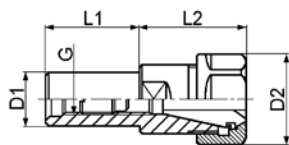

Picture 3

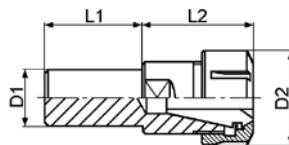

Picture 4

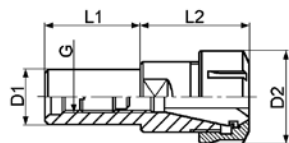

Collet Holders HFER-Z

Description	Order-No.	Pic.	L1	L2	D1	D2	G	Precision Collets
HFER11-Z20-L1=60	26220000060	2	60	18	20	19	M7	GERC11-B/BD• CER11-K2
HFER16-Z10-L1=60	26310000060	1	60	36	10	28	-	GERC16-B/BD• CER16-K2
HFER16-Z12-L1=40	26312000040		40					
HFER16-Z16-L1=60	26316000060		60					
HFER16-Z20-L1=50	26320000050		50					
HFER16-Z20-L1=100	26320000100	2	100	28	20	34	M11	GERC20-B/BD• CER20-K2
HFER20-Z20-L1=50	26420000050		50					
HFER20-Z25-L1=100	26425000100	3	100	27	25	42	M12	GERC25-B/BD• CER25-K2
HFER25-Z16-L1=100	26516000100		100					
HFER25-Z20-L1=50	26520000050		50					
HFER25-Z20-L1=100	26520000100		100					
HFER25-Z25-L1=50	26525000050	4	50	39	25	50	M18	GERC32-B/BD• CER32-K2
HFER25-Z25-L1=100	26525000100		100					
HFER25-Z30-L1=60	26530000060		60					
HFER25-Z3/4"-L1=50	26544000050		50					
HFER25-Z1"-L1=50	26546000050	4	50	54	20	50	M12	GERC32-B/BD• CER32-K2
HFER32-Z20-L1=50	26620000050		50					
HFER32-Z20-L1=100	26620000100		100					
HFER32-Z25-L1=50	26625000050		50					
HFER32-Z25-L1=100	26625000100	60	40	25	30	63	M18	GERC40-B/BD• CER40-K2
HFER32-Z30-L1=60	26630000060			30				
HFER32-Z32-L1=60	26632000060				32		M20	
HFER32-Z32-L1=60	26632000060						M22	
HFER40-Z25-L1=50	26725000050		50	60	25	63	M18	GERC40-B/BD• CER40-K2

**Ordering example:**

HFER32-Z25-L1=50 = Order-No. 26620000050

# Collet Holders with Cylindrical Shank for Precision Collets DIN ISO 15488 (ER/ESX)

**Application:** On (long) turning automatic lathes for holding tools with cylindrical shanks

**Acceptance:** Cylindrical shank without flat • extremely slim construction

**Concentricity and repeatability:** Shank O.D. to collet closing taper  $\leq 5 \mu\text{m}$

**Remark:** Collets, wrenches and nuts as spare parts see pages 13 to 26

**Extend of Delivery:** With mini nut • without collets and wrenches

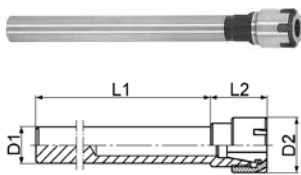

Collet Holders HFERM-Z

Description	Order-No.	L1	L2	D1	D2	Precision Collets
HFER8M-Z6-L1=70	27106000070	70	25	6	12	GERC8-B•CER8-K2
HFER8M-Z8-L1=70	27108000070			8		
HFER8M-Z10-L1=84	27110000080	84	16	10		
HFER8M-Z12-L1=80	27112000080	80	16	12	16	GERC11-B/BD•CER11-K2
HFER11M-Z6-L1=56	27206000056	56	29	6		
HFER11M-Z8-L1=56	27208000056		26	8		
HFER16M-Z10-L1=60	27310000060	60	37	10	22	GERC16-B/BD•CER16-K2
HFER16M-Z12-L1=80	27312000080	80		12		
HFER20M-Z16-L1=100	27416000100	100	38	16	28	GERC20-B/BD•CER20-K2

**Application:** As milling extensions on boring bars for holding tools with cylindrical shanks

**Acceptance:** Cylindrical shank without flat • extremely slim construction

**Concentricity and repeatability:** Shank O.D. to collet closing taper  $\leq 5 \mu\text{m}$

**Remark:** Collets, wrenches and nuts as spare parts see pages 13 to 26

**Extend of Delivery:** With mini nut and inner stop (only for executions with internal thread) • without collets and wrenches



Picture 1

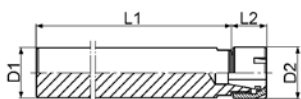

Picture 2

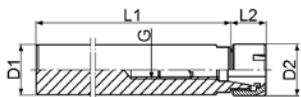

Picture 3

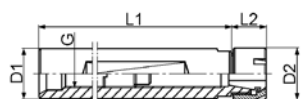

Collet Holders HFERM-Z

Description	Order-No.	Pic.	L1	L2	D1	D2	G	Precision Collets
HFER8M-Z8-L1=125	27108000125	1	125	16	8	12	-	GERC8-B•CER8-K2
HFER8M-Z12-L1=125	27112000125				12			
HFER11M-Z10-L1=80	27210000080	1	80	22	10	16	-	GERC11-B/BD•CER11-K2
HFER11M-Z12-L1=125	27212000125				12			
HFER11M-Z16-L1=125	27216000125	3	125	19	16	M7x0,5	GERC11-B/BD•CER11-K2	
HFER11M-Z16-L1=150	27216000150	2	150					
HFER16M-Z16-L1=150	27316000150	1	150	36	16	22	-	GERC16-B/BD•CER16-K2
HFER16M-Z20-L1=140	27320000140	3	140	23	20			
HFER16M-Z20-L1=170	27320000170	3	170	22	25	M11x1	GERC16-B/BD•CER16-K2	
HFER16M-Z20-L1=200	27320000200		200					
HFER16M-Z25-L1=150	27325000150	3	150	33	20	28	M14x1	GERC20-B/BD•CER20-K2
HFER20M-Z20-L1=150	27420000150	150						
HFER20M-Z25-L1=140	27425000140	3	140	24	25	35	M14x1	GERC25-B/BD•CER25-K2
HFER20M-Z25-L1=150	27425000150		150					
HFER20M-Z25-L1=200	27425000200	200	180	28	30	M18x1	GERC25-B/BD•CER25-K2	
HFER25M-Z20-L1=150	27520000150	150						
HFER25M-Z25-L1=150	27525000150	3	150	36	25	35	M18x1	GERC25-B/BD•CER25-K2
HFER25M-Z30-L1=180	27530000180	180						

**Ordering example:**

HFER11M-Z8-L1=56 = Order-No. 27208000056

# Collet Holders with Cylindrical Shank and Flat for Precision Collets DIN ISO 15488 (ER/ESX)

**Application:** As milling extensions on boring bars for holding tools with cylindrical shanks

**Acceptance:** Cylindrical shank with flat • extremely slim construction

**Concentricity and repeatability:** Shank O.D. to collet closing taper  $\leq 5 \mu\text{m}$

**Remark:** Collets, wrenches and nuts as spare parts see pages 13 to 26

**Extend of Delivery:** With mini nut and inner stop (only for executions with internal thread) • without collets and wrenches

Collet Holders HFERM-ZW



Picture 1

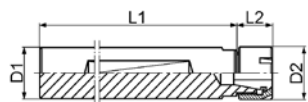

Picture 2

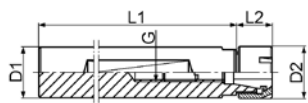

Picture 3

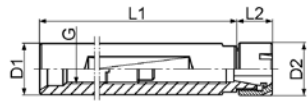

Description	Order-No.	Pic.	L1	L2	D1	D2	G	Precision Collets
HFER8M-ZW6-L1=70	27156000070		70		6			
HFER8M-ZW8-L1=125	27158000125		125		8			
HFER8M-ZW10-L1=80	27160000080	1	80	16	10	12	-	GERC8-B• CER8-K2
HFER8M-ZW12-L1=80	27162000080		80		12			
HFER8M-ZW12-L1=125	27162000125		125					
HFER11M-ZW10-L1=80	27260000080		80	22	10			
HFER11M-ZW10-L1=120	27260000120	1	120		12	16	-	GERC11-B/BD• CER11-K2
HFER11M-ZW16-L1=125	27266000125	3	125	19	16		M7	
HFER11M-ZW16-L1=150	27266000150	2	150					
HFER16M-ZW16-L1=150	27366000150	1	150	36	16		-	GERC16-B/BD• CER16-K2
HFER16M-ZW20-L1=140	27370000140	3	140	23	20	22	M11	
HFER16M-ZW25-L1=150	27375000150		150	22	25			
HFER20M-ZW20-L1=150	27470000150		150	33	20			
HFER20M-ZW25-L1=140	27475000140	3	140					
HFER20M-ZW25-L1=150	27475000150		150	24	25	28	M14	GERC20-B/BD• CER20-K2
HFER20M-ZW25-L1=200	27425000200		200					
HFER25M-ZW20-L1=150	27570000150		150	45	20		M14	
HFER25M-ZW25-L1=100	27575000100	3	100					
HFER25M-ZW25-L1=150	27575000150		150	36	25	35	M18	GERC25-B/BD• CER25-K2

**Ordering example:**

HFER16M-ZW16-L1=150 = Order-No. 27366000150

# Collet Holders with Cylindrical Shank and Flat for Precision Collets DIN ISO 15488 (ER/ESX)

**Application:** On machines with narrow space proportions (e.g. Star and Traub long turning automatic lathes) for holding tools with cylindrical shanks

**Acceptance:** Cylindrical shank with flat • large clamping range with small dimensions • G/N with addition M = inner thread with stop / without addition M = through bore • all holders are available on request

with coolant connection thread in the rear

**Concentricity and repeatability:** Shank O.D. to collet closing taper  $\leq 5 \mu\text{m}$

**Remark:** Collets, wrenches and nuts as spare parts see pages 13 to 26  
**Extend of Delivery:** With mini nut and inner stop (only for executions with internal thread) • without collets and wrenches



Picture 1

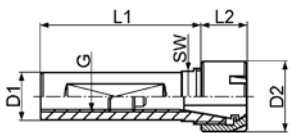

Picture 2

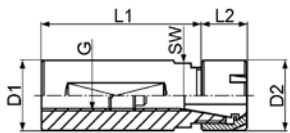

Picture 3

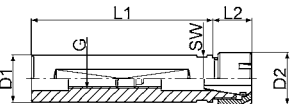

Picture 4

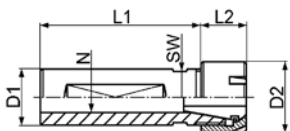

## Collet Holders HFERM-ZW

Description	Order-No.	Pic.	L1	L2	D1	D2	SW	G/N	Precision Collets
HFER11M-ZW16-L1=20	27216000020	4	20	19	16	16	-	7,5	GERC11-B/BD• CER11-K2
HFER11M-ZW16-L1=80	27216000080		80						
HFER11M-ZW3/4"-L1=70	27244000070	2	70		3/4"		17	M7	
HFER16M-ZW16-L1=35	27316000035	1	35	36	16				M8
HFER16M-ZW16-L1=70	27316000070		70						
HFER16M-ZW20-L1=38	27320000038		38				17		GERC16-B/BD• CER16-K2
HFER16M-ZW20-L1=50	27320000050		50		20				
HFER16M-ZW20-L1=70	27320000070		70						
HFER16M-ZW20-L1=120	27320000120		120						
HFER16M-ZW22-L1=70	27322000070		70		22	22	19	M11	GERC16-B/BD• CER16-K2
HFER16M-ZW25-L1=60	27325000060	2	60	23	25		22		
HFER16M-ZW3/4"-L1=50	27344000050		50						
HFER16M-ZW3/4"-L1=70	27344000070		70		3/4"		17		
HFER16M-ZW3/4"-L1=120	27344000120		120						
HFER16M-ZW1"-L1=75	27346000075		75		1"		22		
HFER16M-ZW1"-L1=100	27346000100		100						
HFER20M-ZW20-L1=50	27420000050	1	50	31	20		-	M12	GERC20-B/BD• CER20-K2
HFER20M-ZW25-L1=100	27425000100	1	100	27	25	28	22	M14	
HFER25M-ZW20-L1=75	27520000075	3	75	44	20	35	27	M12	GERC25-B/BD• CER25-K2
HFER25M-ZW25-L1=75	27525000075			38	25			M18	

### Ordering example:

HFER16M-ZW20-L1=120 = Order-No. 27320000120

## Collet Holders with Cylindrical Shank and B Taper with Flat for Precision Collets DIN ISO 15488 (ER/ESX)

**Application:** For holding tools with cylindrical shanks on CNC lathes

**Acceptance:** Cylindrical shank with flat • for internal coolant supply (axial or lateral)

**Concentricity and repeatability:** Shank O.D. to collet closing taper  $\leq 5 \mu\text{m}$

**Remark:** Collets, wrenches and nuts as spare parts see pages 13 to 26

**Extend of Delivery:** With clamping nut DIN ISO 15488 (form E with six slots) and inner stop • without collets and wrenches

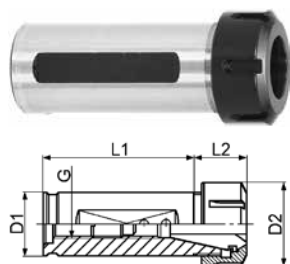

Collet Holders NCER-ZW

Description	Order-No.	L1	L2	D1	D2	G	Precision Collets
NCER25-ZW32-L1=75	26562000075	75	20	32	42	M18	GERC25-B/BD• CER25-K2
NCER25-ZW40-L1=80	26570000080	80	25	40			
NCER32-ZW32-L1=60	26662000060	60	39	32	50	M24	GERC32-B/BD• CER32-K2
NCER32-ZW40-L1=80	26670000080	80	25	40			
NCER32-ZW50-L1=120	26680000120	120		50			
NCER40-ZW32-L1=60	26762000060	60	57	32	63	M22	GERC40-B/BD• CER40-K2
NCER40-ZW40-L1=75	26770000075	75	37	40		M24	
NCER40-ZW50-L1=120	26780000120	120	27	50			

**Application:** For holding tools with cylindrical shanks

**Acceptance:** With drill chuck taper DIN 238 form B and flat • small dimensions

**Concentricity and repeatability:** Shank O.D. to collet closing taper  $\leq 5 \mu\text{m}$

**Remark:** Collets, wrenches and nuts as spare parts see pages 13 to 26

**Extend of Delivery:** With mini nut and inner stop • without collets and wrenches

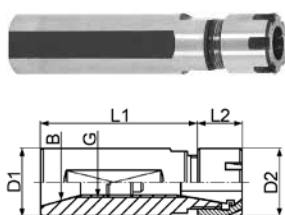

Collet Holders HFERM-B

Description	Order-No.	B	L1	L2	D1	D2	G	Precision Collets
HFER11M-B12-L1=40	2720200	B12	40	19	16	16	M8	GERC11-B/BD• CER11-K2
HFER16M-B12-L1=45	2730200	B12	45	23	22	22	M10	GERC16-B/BD• CER16-K2
HFER20M-B16-L1=50	2740300	B16	50	25	25	28	M14	GERC20-B/BD• CER20-K2

**Ordering example:**

NCER40-ZW40-L1=75 = Order-No. 26770000075

# Tapping Attachments and Tapping Holder with Morse Taper

**Indication: not appropriate for large-scale production!**

**Application:** On all conventional drill presses and radial arm drill presses for right hand tapping on non-reversing spindles (where you work with hand feed) for holding taps

**Acceptance:** Morse taper with tang DIN 228-B

**Special features:** Rapid backout 2:1 with inbuilt planetary gear drive • immediate reversal with change of feed direction • safety clutch infinitely

tely adjustable by rotation and locking of graduated collar • conversion from slipping clutch to friction operation by simply turning over the cam ring (for small threads) • suitable for right or left hand threads • clamping jaw mechanism grips all tap shanks within unit's capacity including intermediate and inch sizes

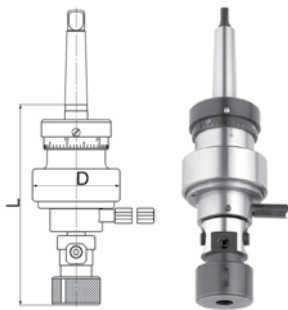

Tapping Attachments GAN

Description	Order-No.	MK	Cutting range*	Clamping range	Speed max. r.p.m.	D	L
GAN10-MK1	5631100	1	M3-M10 (M12)	2,5-10 mm	600	69	156
GAN10-MK2	5631200	2	#6-3/8" (1/2")				158
GAN16-MK2	5632200	2	M6-M16	4,5-12,5 mm	400	82	183
GAN16-MK3	5632300	3	1/4"-5/8"				
GAN27-MK3	5633300	3	M14-M27 (M30)	11-22,4 mm	250	105	244
GAN27-MK4	5633400	4	9/16"-1.1/8" (1.1/4")				246

\* Cutting range refers to materials with tensile strength of 500 N/mm2

( ) for light machining only, e.g. aluminium, grey cast iron, steel up to max. 350 N/mm2 and fine pitch threads

**Application:** For cutting of internal threads with drill presses, radial drill presses and vertical drill presses with reversing spindles

**Acceptance:** Morse taper with tang DIN 228-B

**Special features:** Without rapid backout • safety clutch infinitely adjustable by rotation and locking of graduated collar • conversion from

slipping clutch to friction operation by simply turning over the cam ring (for small threads) • suitable for right or left hand threads • clamping jaw mechanism grips all tap shanks within unit's capacity including intermediate and inch sizes

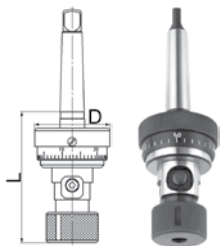

Tapping Holder GHN

Description	Order-No.	MK	Cutting range*	Clamping range	Speed max. r.p.m.	D	L
GHN10-MK1	5636100	1	M3-M10 (M12)	2,5-10 mm	600	55	93
GHN10-MK2	5636200	2	#6-3/8" (1/2")				95
GHN16-MK2	5637200	2	M6-M16	4,5-12,5 mm	400	68	123
GHN16-MK3	5637300	3	1/4"-5/8"				
GHN27-MK3	5638300	3	M14-M27 (M30)	11-22,4 mm	250	88	167
GHN27-MK4	5638400	4	9/16"-1.1/8" (1.1/4")				169

\* Cutting range refers to materials with tensile strength of 500 N/mm2

( ) for light machining only, e.g. aluminium, grey cast iron, steel up to max. 350 N/mm2 and fine pitch threads

**Ordering example:**

GAN16-MK3 = Order-No. 5632300

## Quick Change Chucks with Morse Taper Shank and Adaptors

**Application:** On vertical drilling and boring machines with right and left hand spindle rotation

**Acceptance:** Morse taper with tang DIN 228-B

**Special features:** Competitive price • simple and uncomplicated design • high practical value • long lifetime

**Remark:** With quick change adaptors E for drilling and counter bores, PE for reaming and GE for tapping a machine can quickly and easily be changed over from one bore to the next resp. from drilling to reaming or tapping

Quick Change Chucks SF

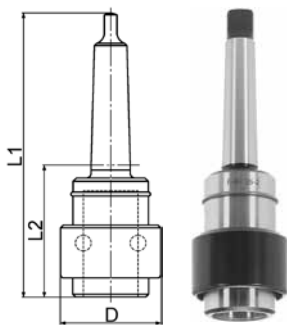

Description	Order-No.	MK	for boring into steel	L1	L2	D	Adaptors
SF26-MK2	3100200	2	24,0 mm Ø	150	75,5	48	E26•PE26•GE26
SF34-MK3	3100300	3	32,0 mm Ø	176	82	61	E34•PE34•GE34
SF46-MK4	3100400	4	50,0 mm Ø	222	104	86	E46•PE46•GE46
SF60-MK5	3100500	5	60,0 mm Ø	282	133	107	E60•PE60•GE60

**Application:** For acceptance of split sleeves DIN 6329 (see Page 31) for clamping cylindrical twist drills with tangs and counterbores or cutting tools with Morse taper

**Special features:** Female taper • ejection slot

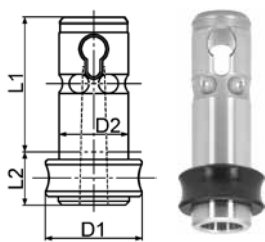

Tool Adaptors E-MK with Female Taper

Description	Order-No.	MK	L1	L2	D1	D2	Split Sleeves
E26-MK1	3110300	1	60	18	37	26	FM500/1
E26-MK2	3110400	2		30			FM500/2
E34-MK1	3110500	1	65	22	46	34	FM500/1
E34-MK2	3110600	2		26			FM500/2
E34-MK3	3110700	3		43			FM500/3
E46-MK1	3110800	1	82	23	58	46	FM500/1
E46-MK2	3110900	2		27			FM500/2
E46-MK3	3111000	3		27			FM500/3
E46-MK4	3111100	4		53			FM500/4
E60-MK2	3111200	2	105	26	74	60	FM500/2
E60-MK3	3111300	3		29			FM500/3
E60-MK4	3111400	4		29			FM500/4
E60-MK5	3111500	5		68			FM500/5

**Ordering example:**

SF34-MK3 = Order-No. 3100300

# Quick Change Chucks with Morse Taper Shank and Adaptors

**Application:** For clamping cylindrical twist drills and counterbores  
**Remark:** Collets, wrenches and nuts as spare parts see pages 13 to 26

**Extend of Delivery:** With clamping nut DIN ISO 15488 (with hexagon head form D for E26 – rest form E with six slots) and inner stop • without collets and wrenches

## Tool Adaptors E-ER for Collets DIN ISO 15488 (ER/ESX)

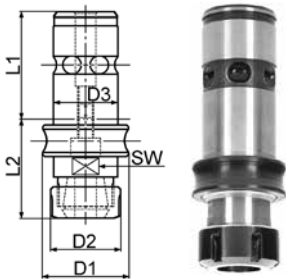

Description	Order-No.	L1	L2	D1	D2	D3	SW	Precision Collets
E26-ER20	3112000	60	56	37	34	26	22	GERC/CER20
E34-ER25	3112300	65	63	46	42	34	30	GERC/CER25
E46-ER32	3112600	82	74	58	50	46	36	GERC/CER32
E60-ER40	3112900	105	79	74	63	60	46	GERC/CER40

**Application:** For clamping reamers  
**Special features:** With radial, parallel floating (P)  
**Remark:** Collets, wrenches and nuts as spare parts see pages 13 to 26

**Extend of Delivery:** With clamping nut DIN ISO 15488 (with hexagon head form D for PE26 – rest form E with six slots) and inner stop • without collets and wrenches

## Floating Adaptors PE-ER for Precision Collets DIN ISO 15488 (ER/ESX)

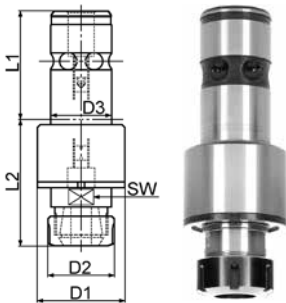

Description	Order-No.	P	L1	L2	D1	D2	D3	SW	Precision Collets
PE26-ER20	3116000	1	60	81	50	34	26	22	GERC/CER20
PE34-ER25	3116300	1	65	84	50	42	34	30	GERC/CER25
PE46-ER32	3116600	1,5	82	101	67	50	46	36	GERC/CER32
PE60-ER40	3116900	2	105	118	88	63	60	46	GERC/CER40

**Application:** For acceptance of split sleeves DIN 6328 (see Page 31) for clamping taps with square drive

**Special features:** Female taper • adjustable safety slip clutch • scale of approximate values • ejector pin

## Tapping Adaptors GE-MK with Female Taper

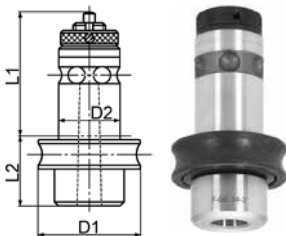

Description	Order-No.	MK	Cutting range	L1	L2	D1	D2	Split Sleeves
GE26-MK1	3120100	1	M1-M10	60	28	43	26	FM501/1
GE26-MK2	3120200	2	M4-M16		39			FM501/2
GE34-MK1	3120300	1	M1-M10	65	23	56	34	FM501/1
GE34-MK2	3120400	2	M4-M16		37			FM501/2
GE34-MK3	3120500	3	M8-M20		53			FM501/3
GE46-MK2	3120600	2	M4-M16	82	28	70	46	FM501/2
GE46-MK3	3120700	3	M8-M20		42			FM501/3
GE46-MK4	3120800	4	M16-M33		67			FM501/4
GE60-MK3	3120900	3	M8-M20		45			FM501/3
GE60-MK4	3121000	4	M16-M33	105	58	84	60	FM501/4
GE60-MK5	3121100	5	M22-M39					91

**Ordering example:**  
 GE46-MK2 = Order-No. 3120600



## Quick Change Chucks with Morse Taper Shank and Adaptors

**Application:** For use with off-the-shelf quick change tap adaptors with and without adjustable safety clutch for clamping taps with square  
**Special features:** Without clutch • without length compensation

**Remark:** We do not have the quick change tap adaptors in our delivery programme

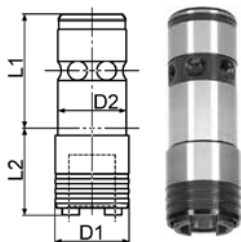

Tapping Adaptors GE-GR for Quick Change Tap Adaptors

Description	Order-No.	Cutting range	L1	L2	D1	D2	Adaptors
GE26-GR1	3122100	M3-M12	60	44	32	26	WE/WESB1
GE26-GR2	3122200	M8-M20		61	50		WE/WESB2
GE34-GR1	3122600	M3-M12	65	44	32	34	WE/WESB1
GE34-GR2	3122700	M8-M20		61	50		WE/WESB2
GE46-GR1	3123100	M3-M12	82	44	32	46	WE/WESB1
GE46-GR2	3123200	M8-M20		61	50		WE/WESB2
GE46-GR3	3123300	M14-M33		90	72		WE/WESB3
GE60-GR2	3123700	M8-M20	105	61	50	60	WE/WESB2
GE60-GR3	3123800	M14-M33		90	72		WE/WESB3
GE60-GR4	3123900	M22-M48		110	95		WE/WESB4

**Application:** For use with off-the-shelf quick change tap adaptors with and without adjustable safety clutch for clamping taps with square  
**Special features:** Without clutch • with length compensation on compression and tension (C/T)

**Remark:** We do not have the quick change tap adaptors in our delivery programme

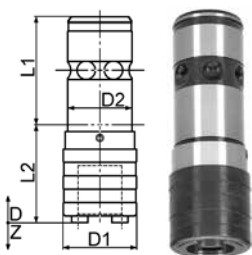

Tapping Adaptors GE-GRL with Length Compensation for Quick Change Tap Adaptors

Description	Order-No.	Cutting range	D/Z	L1	L2	D1	D2	Adaptors
GE26-GRL1	3124100	M3-M12	7,5	60	45	36	26	WE/WESB1
GE26-GRL2	3124200	M8-M20	12,5		69	53		WE/WESB2
GE34-GRL1	3124600	M3-M12	7,5	65	45	36	34	WE/WESB1
GE34-GRL2	3124700	M8-M20	12,5		69	53		WE/WESB2
GE46-GRL1	3125100	M3-M12	7,5	82	45	36	46	WE/WESB1
GE46-GRL2	3125200	M8-M20	12,5		69	53		WE/WESB2
GE46-GRL3	3125300	M14-M33	20		102	78		WE/WESB3
GE60-GRL2	3125700	M8-M20	12,5	105	69	53	60	WE/WESB2
GE60-GRL3	3125800	M14-M33	20		102	78		WE/WESB3
GE60-GRL4	3125900	M22-M48	22,5		113	96		WE/WESB4

**Ordering example:**  
 GE60-GRL3 = Order-No. 3125800

# Concentricity Charts

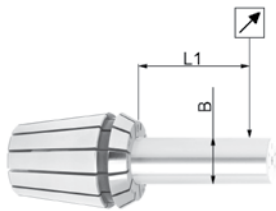

## Concentricity DIN ISO 15488 (ER/ESX) resp. FAHRION Quality

B mm		L1 mm	DIN Class 2	Class 1	FAHRION Quality	
from	to				B	HP*
1,0	1,6	2-3	0,015	0,010	0,005	0,002
1,6	3,0	10				
3,0	7,0	16				
7,0	10,0	25	0,020	0,015	-	-
10,0	18,0	40				
18,0	26,0	50				
26,0	34,0	60	0,025	0,020	-	-

\* checked with HPplus chuck in three equi-spaced positions (moved clockwise by 120°) at a distance of 3xD (max. 50 mm)

Concentricity for collets DIN ISO 15488 (ER/ESX) on pages 13 to 21.

The tolerances are classified to DIN into two classes:

= Class 2 is our standard for CER-K2 and CET-GB (on pages 18 and 21)

= 10 µm (higher TIR) is our standard for GERC-GBD and GERC-GBDD (on pages 19 and 20)

= FAHRION quality is our standard (average concentricity with a repeatability of 5 µm resp. 2 µm) for GERC-B / -BD resp. GERC-HP / -HPD / -HPDD – details see at the respective description (on pages 13 and 17)

Test method (except for GERC-HP / -HPD / -HPDD) see below

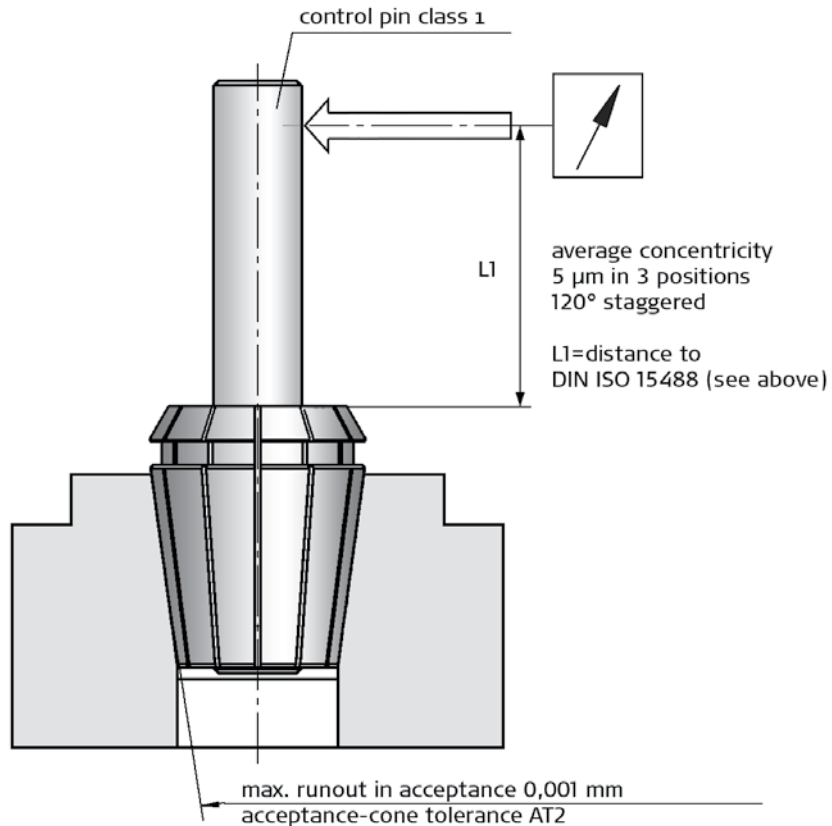

**For applications which require highest concentricity, it is absolutely necessary to pay attention to the complete system (machine spindle, collet acceptance, clamping nut, collet and cutting tool).**

# Concentricity Charts | Build-in Dimensions

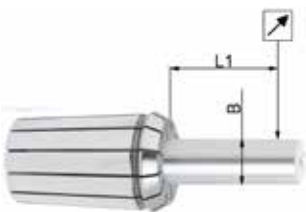

### Concentricity DIN ISO 10897 (OZ) resp. FAHRION Quality

B mm	L1 mm	DIN Class 2	Class 1	FAHRION Quality Standard	HP
from 1,0 to 1,6	2-3	0,015	0,010	-	-
1,6 to 3,0	10			0,006	0,003
3,0 to 7,0	16				
7,0 to 10,0	25				
10,0 to 18,0	40	0,020	0,015	0,010	-
18,0 to 25,0	50				
25,0 to 30,0	60	0,030	0,020	0,015	-
30,0 to 40,0	60				

Concentricity for collets DIN ISO 10897 (OZ) on page 27.

The tolerances are classified to DIN into two classes, whereas our quality is better than DIN:

= FAHRION quality is our standard (average concentricity with a repeatability of 6 µm resp. 3 µm) for GOZ-DG and GOZ-DG-HP – details and exceptions see ☑ at the respective description (on page 27)

Test method (except for GOZ-DG-HP) see DIN ISO 15488 (ER/ESX)

**For applications which require highest concentricity, it is absolutely necessary to pay attention to the complete system (machine spindle, collet acceptance, clamping nut, collet and cutting tool).**

### Precision Collets and Clamping Nuts DIN ISO 15488 (ER/ESX)

Picture 1

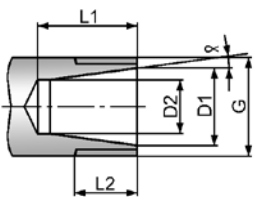

Picture 2

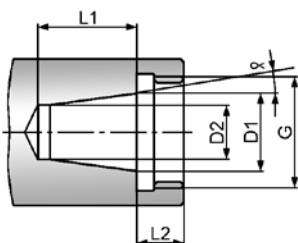

Description	Pic.	L1	L2	D1	D2	G	a	Collets	Range		
STM11D	1	17	10	11	7,5	M14x0,75	8°	4008E	0,5-7,0		
STM16D+E		22	13	16	10,5	M22x1,5		426E	0,5-10,0		
STM20D+E		26,5	13,5	20	13,5	M25x1,5		428E	0,5-3,0		
STM25E		30	14	25	17,5	M32x1,5		430E	0,5-16,0		
STM32E		35	16	32	23,5	M40x1,5		470E	1,0-20,0		
STM40E		40	17	40	30,5	M50x1,5		472E	2,0-26,0		
STM50E		48	24	50	38	M64x2		477E	4,0-34,0		
STM8M	1	13	7,5	8	5,2	M10x0,75	8°	4004E	0,5-5,0		
STM11M		17	10	11	7,5	M13x0,75		4008E	0,5-7,0		
STM16M		22	13	16	10,5	M19x1		426E	0,5-10,0		
STM20M		26,5	13,5	20	13,5	M24x1		428E	0,5-13,0		
STM25M		30	14	25	17,5	M30x1		430E	0,5-16,0		
STM11A		2	23	7	11	7,5		M18x1	8°	4008E	0,5-7,0
STM16A			32	10	16	10,5		M24x1		426E	0,5-10,0
STM20A	37,5		11	20	13,5	M28x1,5	428E	0,5-13,0			
STM25A	41		12	25	18	M32x1,5	430E	0,5-16,0			
STM32A	48		14	32	23,5	M40x1,5	470E	1,0-20,0			

**Remark:** The exact tolerances for the manufacture of your spindle are available upon request

# Tightening Torque

Picture 1

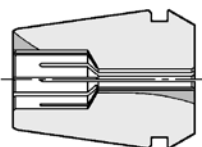

Picture 2

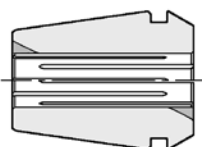

## Tightening Torque for Clamping Nuts DIN ISO 15488 (ER/ESX)

Collets type	Clamping Nuts	with short bore (Picture 1)		with through bore (Picture2)	
		Clamping-Ø	max. torque	Clamping-Ø	max. torque
GERC8	STM8M	1,0-2,5	5 Nm	3,0-5,0	8 Nm
	STM11D		13 Nm		25 Nm
GERC11	STM11M	1,0-2,5	11 Nm	3,0-7,0	18 Nm
	STM11A		13 Nm		24 Nm
GERC16	STM16D	1,0-4,5	30 Nm	5,0-10,0	50 Nm
	STM16E				18 Nm
	STM16E-DI		22 Nm		
	STM16M				
STM16M-DI					
STM16A					
GERC20	STM20D	1,0-6,5	45 Nm	7,0-13,0	75 Nm
	STM20E				22 Nm
	STM20E-DI		24 Nm		
	STM20M				
STM20M-DI					
STM20A					
GERC25	STM25E	1,0-6,5	55 Nm	7,0-16,0	85 Nm
	STM25E-DI		24 Nm		40 Nm
	STM25M				28 Nm
STM25M-DI					
STM25A					
GERC32	STM32E	2,0-6,5	70 Nm	7,0-20,0	105 Nm
	STM32E-DI		36 Nm		60 Nm
STM32A					
GERC40	STM40E	3,0-7,5	100 Nm	8,0-26,0	150 Nm
	STM40E-DI				

**Remark:** The tables below show the maximum tightening torque values in relation to the clamping-Ø of the collet with short bore or through bore (see pictures 1 and 2) • the smaller the clamping-Ø the lower the necessary torque value • high torque leads to damage of clamping nut resp. collet closing taper

# Assembly

## Assembly Instruction for Precision Collets DIN ISO 15488 (ER/ESX)

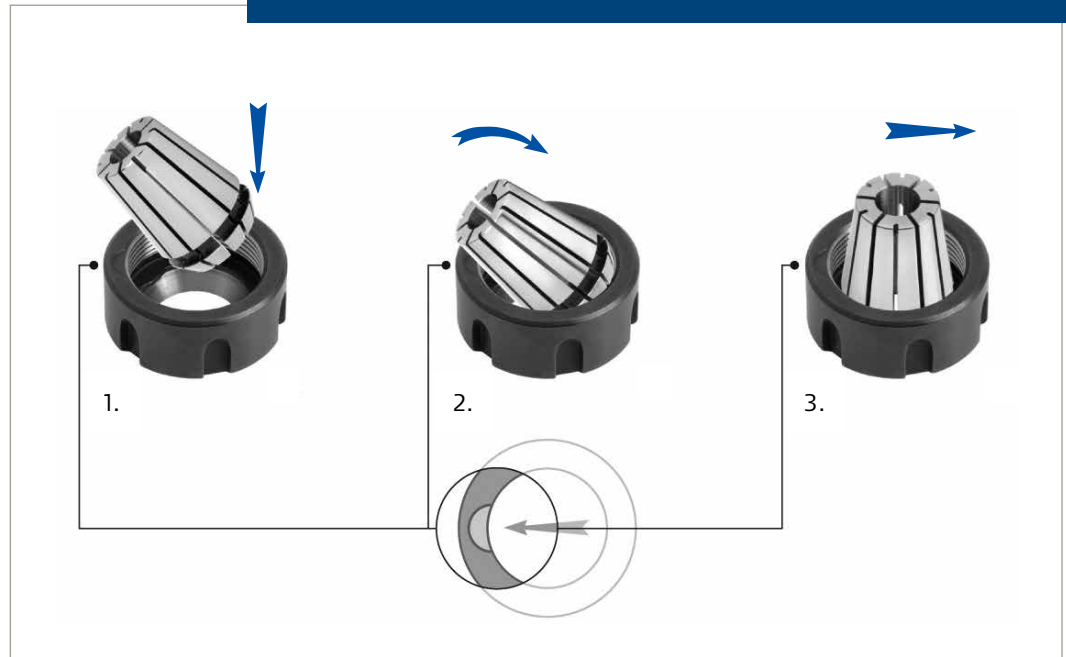

**Assembly:** For Clamping nuts with EasyClick: see photos • for Mini Clamping Nuts only: feed the collet into the nut and turn until the eccentric ring of the nut engages in the groove of the collet

**Remark:** Fit the assembly into the collet chuck or the machine spindle • do not clamp shanks larger than the nominal size indicated!

## Assembly Instruction for Precision Collets DIN ISO 10897 (OZ)

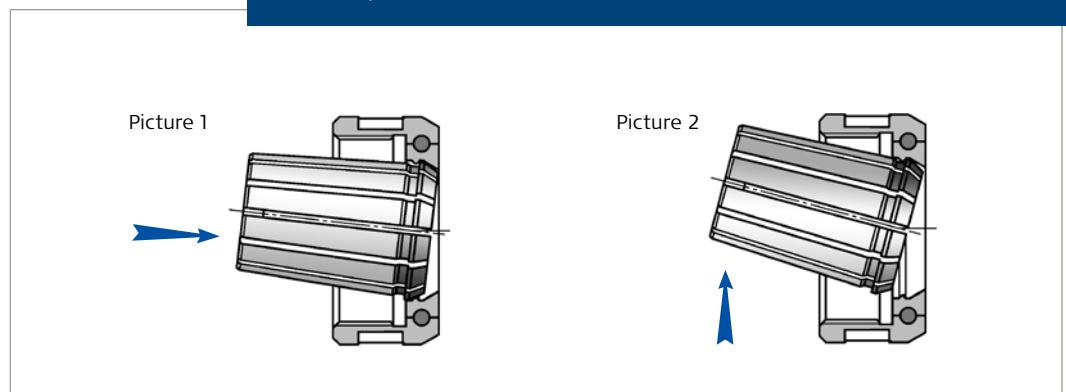

**Assembly:** Lay the collet in the groove and press axially until it is fixed (Picture 1)

**Changing:** Remove the nut and again through a lateral pressure the collet springs out of the groove of the nut (Picture 2)

**Remark:** Please take care that the collet is only clamped with the inserted cutting tool • do not clamp shanks larger than the nominal size indicated!

# DIN Tap Shank Dimensions

DIN Tap Shank Dimensions											
Ø x □	DIN 352	DIN5156 DIN5157	DIN 371	DIN 374	DIN 376	BSW DIN 2183	BSW reinforce DIN 2182	UNC DIN 376	UNC reinforce DIN 371	UNF DIN 374	UNF reinforce DIN 371
2,5x2,1	M1		M1		M3,5		1/16"				
	M1,1		M1,1	M3,5							
	M1,2		M1,2								
	M1,4		M1,4								
	M1,6		M1,6								No.2-64
	M1,8		M1,8						No.6-32	No.6-40	No.3-56
2,8x2,1	M2		M2	M4	M4	5/32"	3/32"	No.8-32			
	M2,2		M2,2						No.2-56		
	M2,5		M2,5+M2,6						No.3-48	No.8-36	
3,5x2,7	M3		M3	M5	M5+M4,5	1/8"		No.5-40		No.5-44	
4x3	M3,5		M3,5	M5,5			7/32"	No.12-24	No.6-32	No.12-28	No.6-40
4,5x3,4	M4		M4	M6	M6	1/4"	5/32"	1/4"-20	No.8-32	1/4"-28	No.8-36
5,5x4,5				M7	M7						
6x4,9	M5	G1/16"	M4,5					5/16"-18			No.10-32
	M6		M5						No.10-24		No.12-28
	M8		M6	M8	M8				No.12-28		
7x5,5	M10	G1/8"	M7	M9+M10	M9+M10	3/8"	1/4"	3/8"-16	1/4"-20	3/8"-24	1/4"-28
8x6,2			M8	M11		7/16"	5/16"		5/16"-18		5/16"-24
9x7	M12		M9	M12	M12	1/4"	3/8"	1/2"-13	3/8"-16	1/2"-20	3/8"-24
10x8			M10								
11x9	M14			M14	M14	G1/4"	9/16"				
12x9	M16	G3/8"	M12	M16	M16	5/8"		5/8"-11		5/8"-18	
14x11	M18			M18	M18	11/16"		3/4"-10		3/4"-16	
16x12	M20	G1/2"		M20	M20	13/16"					
18x14,5	M22	M5/8"		M22	M22	7/8"					
	M24			M24	M24	15/16"					
20x16	M27	G3/4"		M27	M27	1"					
22x18	M30	G7/8"		M30	M30	1.1/8"					
25x20	M33	G1"		M33	M33	1.1/4"					
28x22	M36	G1.1/8"		M36	M36	1.3/8"					
32x24	M39	G1.1/4"		M39	M39	1.1/2"					
	M42			M42	M42	1.5/8"					
36x29	M45	G1.3/8"		M45	M45	1.3/4"					
	M48	G1.1/2"		M48	M48	1.7/8"					
		G1.3/4"									
		G2"									
40x32	M52	G2.1/4"		M52	M52	2"					
45x35	M56	G2.1/2"			M56	2.1/4"					
	M60				M60						
50x39	M64	G2.3/4"			M64						
		G3"									
56x44	M68	G3.1/4"			M68	2.3/4"					
						3"					

# ISO Tap Shank Dimensions

## ISO Tap Shank Dimensions

Ø x □	ISO 529-1975										
	Metric reinforce		UNC reinforce		UNF reinforce		BSW reinforce		BSF reinforce		BA reinforce
2,24x1,8	M3		No.5-40		No.5-44		1/8"-40				No.5
2,5x2,0	M3,5	M2	No.6-32	No.1-64	No.6-40	No.0-80					No.11
						No.1-72					No.10
2,8x2,24		M2,2				No.2-64					No.8
		M2,5		No.3-48		No.3-56					No.7
3,15x2,5	M4	M3				No.4-48					No.6
			No.8-32	No.5-40	No.8-36	No.5-44					No.5
3,55x2,8	M4,5	M3,5	No.10-24	No.6-32	No.10-32	No.6-40	3/16"-24		3/16"-32		No.3
4x3,15	M5	M4	No.12-24		No.12-28				7/32"-24		No.2
4,5x3,55	M6		1/4"-20	No.8-32	1/4"-28	No.3-36	1/4"-20		1/4"-26		No.1
5x4		M5		No.10-24		No.10-32		3/16"-24		3/16"-32	No.0
5,6x4,5				No.12-24		No.12-28			9/32"-26	7/32"-28	No.2
6,3x5	M8	M6	5/16"-18	1/4"-20	5/16"-24	1/4"-28	5/16"-18	1/4"-20	5/16"-32	1/4"-26	No.1
7,1x5,6			3/8"-16		3/8"-24		3/8"-16		3/8"-20	9/32"-26	No.0
8x6,3	M10	M8	7/16"-14	5/16"-18	7/16"-20		3/8"-16	5/16"-18	7/16"-18	5/16"-22	
9x7,1	M12		1/2"-13		1/2"-20		1/2"-13		1/2"-12		
10x8		M10		3/8"-16		3/8"-24		3/8"-16		3/8"-20	
11,2x9	M14		9/16"-12		9/16"-18		9/16"-12		9/16"-16		
12,5x10	M16		5/8"-11		5/8"-18		5/8"-11		3/8"-14		
14x11,2	M18		3/4"-10		3/4"-16		11/16"-14		11/16"-14		
	M20						3/4"-10		3/4"-12		
16x12,5	M22		7/8"-9		7/8"-14		7/8"-9		7/8"-11		
18x14	M24		1"-8		1"-12		1"-8		1"-10		
20x16	M27		1.1/8"-7		1.1/8"-12		1.1/8"-7		1.1/8"-9		
	M30										
22,4x18	M33		1.1/4"-7		1.1/4"-12		1.1/4"-7		1.1/4"-9		
25x20	M36		1.3/8"-6		1.3/8"-12				1.3/8"-8		
28x22,4	M39		1.1/2"-6		1.1/2"-12		1.1/2"-6		1.1/2"-8		
	M42								1.5/8"-8		
31,5x25	M45		1.3/4"-5				1.3/4"-5		1.3/4"-7		
	M48										
35,5x28	M52		2"-4.1/2				2"-4.1/2		2"-7		
	M56										
40x31,5	M60		2.1/4"-4.1/2				2.1/4"-4		2.1/4"-6		
	M64		2.1/2"-4				2.1/2"-4		2.1/2"-6		
45x35,5	M68		2.3/4"-4				2.3/4"-3.1/2		2.3/4"-6		
			3"-4				3"-3.1/2		3"-5		
50x40			3.1/4"-4				3.1/4"-3.1/4		3.1/4"-5		
			3.1/2"-4				3.1/2"-3.1/4		3.1/2"-4.1/2		
56x45			3.3/4"-4				3.3/4"-3		3.3/4"-4.1/2		
			4"-4				4"-3		4"-4.1/2		

**FAHRION** <sup>®</sup>  
**PRÄZISION**

*And all runs smoothly.*

FAHRION offers a wide selection of precision collets, precision collet chucks as well as precision products for workpiece clamping which fulfil maximum requirements in terms of concentricity, service life and manufacturing quality. In doing so, FAHRION pays particular attention to user-friendly technology oriented towards the practical requirements of the users, which is constantly advanced.

The latest catalogue information is available  
at any times at [www.fahrion.de](http://www.fahrion.de)

FAHRION Vertriebs-GmbH  
Forststraße 54  
73667 Kaisersbach  
Germany  
Phone +49 7184 9282-0  
Fax +49 7184 9282-92  
[info@fahrion.de](mailto:info@fahrion.de)  
[www.fahrion.de](http://www.fahrion.de)  
[www.shop.fahrion.de](http://www.shop.fahrion.de)